

**NEW**

# **TR4F** *type*

Radius Mill TR4F type

*Series expansion of inserts  
with breaker to 5000 type*



**MOLDINO Tool Engineering, Ltd.**

New Product News | No.2003E-6 | 2022-10

The groundbreaking TR4F type,  
with cutting depth of 2 mm × 2 mm feed rate per tooth

» Overcomes all major issues encountered in mold machining, thanks to TR4F's three unique features

» **POINT 1**

Even with interrupted cutting

# High chipping resistance

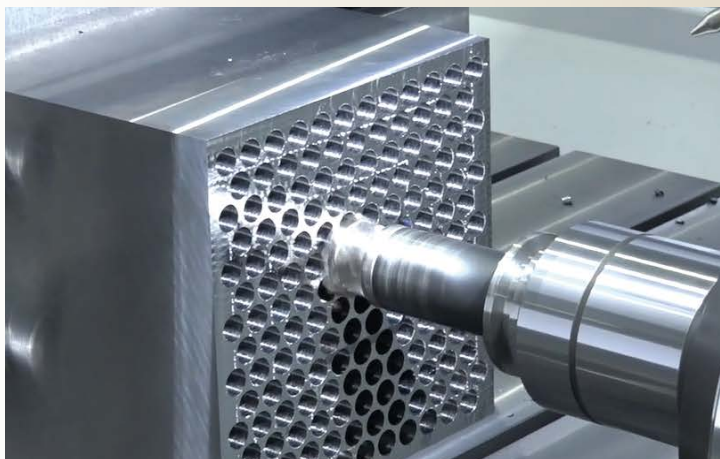

The definitive type  
—even with

Selection of close pitch type

**4000**  
Type



**1 mm × 2 mm**  
Cutting depth Feed per tooth



## Tool performance that maximizes the machine's full capabilities

Rugged cutting, regardless of load, thanks to the unique insert shape

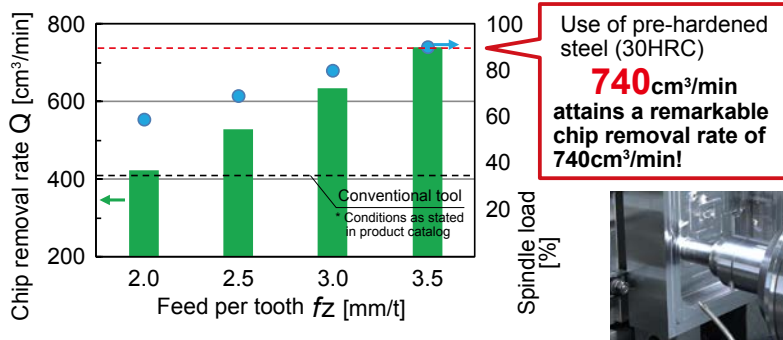

**[Cutting conditions] TR4F5000 type**

Tool dia. :  $\phi 63$  Cutting speed :  $v_c=130\text{m/min}$

Depth of cut :  $a_p \times a_e=2.0 \times 40\text{mm}$

Work material : Pre-hardened steels (30HRC)

Machine : 3-axis MC horizontal type (BT50,37kw)

» **POINT 3**

Even in chips

# Minimized



for rough machining  
large molds

Deep  
cutting  
**5000**  
Type



**2mm × 2mm**  
Cutting depth      Feed per tooth



Even with wall  
face processing

# Prevents scraping



## Chip ejection path away from work surface

Prevents scraping due to chip breakage and bending, which often occurs during wall face machining, whether cutting up or down.

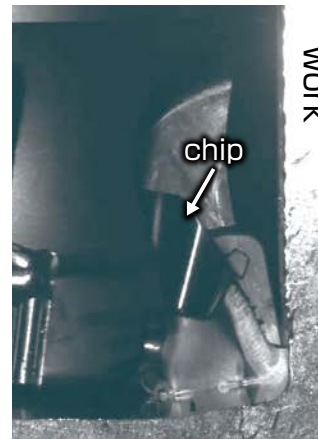

### [Cutting conditions] TR4F5000 type

Tool dia. :  $\phi 63$       Cutting speed :  $V_c=100\text{m/min}$   
Feed rate :  $f_z=2.0\text{mm/t}$       Depth of cut :  $a_p \times a_e=2.0 \times 37.8\text{mm}$   
Work material : Pre-hardened steels (32HRC)

# biting risk



Roughing technique achieves “super” high-feed cutting.

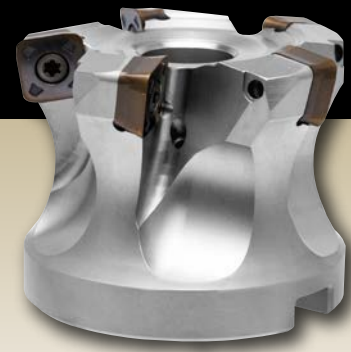

## Exclusive high-efficiency cutting, resulting from unique insert and body shapes

### TR4F type to meet specific challenges posed by high-efficiency cutting

Issue  
**01**

Although high-feed cutting is performed for shaping, resulting severe chip clogging and biting may reduce shaping efficiency.



## Proposed solutions

- Adopts new body shape to enhance chip removal.  
Suppresses chip clogging, even when cutting long overhangs.

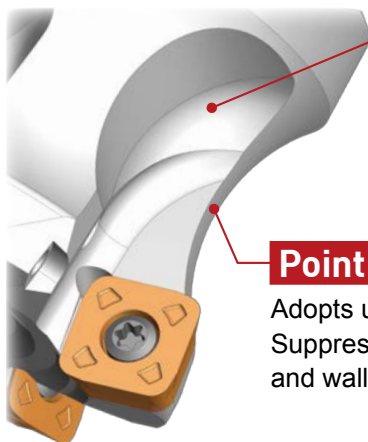

#### Point 1

Offers excellent chip removal performance thanks to large open pocket.

#### Point 2

Adopts unique constricted shape. Suppresses chip clogging between tools and wall surfaces.

- Generation of smooth twist-free chips

Conventional tool TR4F type



#### [Cutting conditions]

Tool dia. :  $\phi 63$   
Cutting speed :  $V_c = 130\text{m/min}$   
Feed rate :  $f_z = 1.0\text{mm/t}$   
Depth of cut :  $a_p \times a_e = 1.0 \times 38\text{mm}$   
Work material : S50C (220HB)

## Point

### Cutting edge designed to control chip flow

- Optimizes cutting edge design to achieve smooth chip removal flow; keeps chips away from wall surfaces. Suppresses clogging from the time chip generation starts.

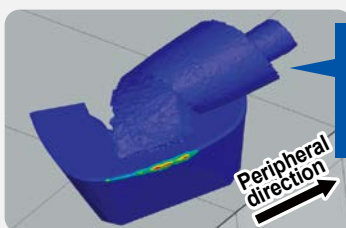

Conventional tool

Helical chips spreading in peripheral direction (on wall surface side)

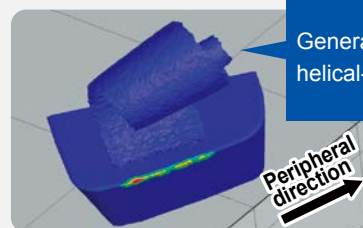

TR4F type

Generates helical-shaped chips

	JM4160	JP4120	JP4105
JS4060			
GX2140			
Copper	Carbon steels	Stainless steels	Pre-hardened steels
	Alloy steels	Tool steels	Hardened steels
			Hardened steels
			30-45HRC
			45-50HRC
			50-60HRC

Applications

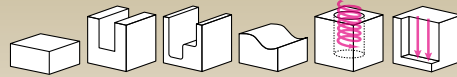

# Issue 02

**New equipment installed to improve the efficiency of the roughing process.**  
**The goal is to reduce machining times with high-feed cutting. But higher feed rates reduce tool life and keep the machine away from delivering its full potential.**



## Proposed solutions

- Developed a unique insert shape. Performs stable machining despite large cutting load generated during high-feed cutting with large cross-sectional and constraint areas.
- Adopts unique unequal pitch method to reduce chattering during cutting.

	Conventional tool	TR4F type
<b>Cross-sectional area</b>	 100%	 <b>110%</b>
<b>Constraint area</b>	 100%	 <b>135%</b>

- Secures insert strength and constraint force by enlarging cross-sectional and constraint areas even in high-load cutting.

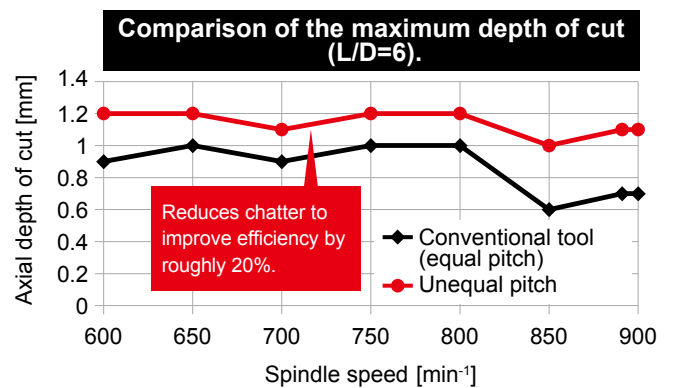

**[Cutting conditions]**

Tool dia. :  $\phi 50$ , No. of Flutes : 4 Flutes,  
 $f_z=1.0\text{mm/t}$ ,  $a_e=35\text{mm}$ , OH=300mm  
 Work material : S50C (220HB)

- Unequal pitch reduces a vibration, a major factor of chattering.



### Point

**Meets the requirements of various applications and steel types.**

- The unique cross-sectional shape and cutting edge design of a single insert meets the needs of a wide range of cutting modes.
- Diverse lineup of insert grades to meet the demands posed by a wide range of work materials.

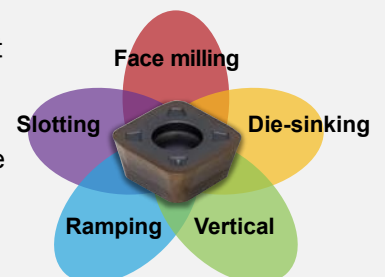

# Line Up

## Shank type

### TR4F40 $\circ$ $\square$ 32- $\circ$

Numeric figure comes in a circle  $\circ$  and alphabetical character comes in a square  $\square$ .



Fig.1 (Standard type)

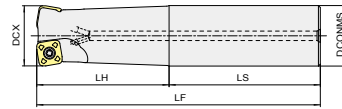
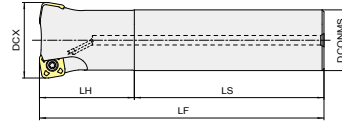

Fig.2 (Undercut type)



With air hole

Type	Item code	Stock	No. of flutes	Size (mm)					Shape	Recommended insert
				DCX	LF	LH	LS	DCONMS		
Regular	TR4F4032S32-2	●	2	32	150	70	80	32	Fig.1	SDNW120520TR(-P) SDMT120520TR
	TR4F4040S32-3	●	3	40	150	50	100	32	Fig.2	
Long	TR4F4032L32-2	●	2	32	200	120	80	32	Fig.1	
	TR4F4040L32-3	●	3	40	250	50	200	32	Fig.2	

## Modular type

### TR4F40 $\circ$ $\circ$ M- $\circ$

Numeric figure comes in a circle  $\circ$ .

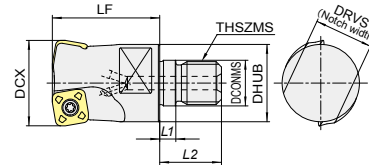

With air hole

Item code	Stock	No. of flutes	Size (mm)								Recommended insert
			DCX	LF	L1	L2	DCONMS	DHUB	THSZMS	DRVS	
TR4F4032M-2	●	2	32	40	6	23	17	28.8	M16	22	SDNW120520TR(-P) SDMT120520TR
TR4F4040M-3	●	3	40	40	6	23	17	28.8	M16	22	

[Note] When \* and carbide shank are used together as a set, there is no interference.

Do not apply lubricants such as grease, etc. to the "contact faces" and "modular screws" of the "modular mill", "dedicated shanks" and "dedicated arbor".

## Parts

Parts	Clamp screw	Wrench	Screw anti-seizure agent	Arbor screw					
Shape									
Cutter body	Fastening torque (N·m)			a	$\phi b$	c	d	f	
TR4F40 $\circ$ S/L/M(32)- $\circ$	262-141	2.9	105-T15	—	—	—	—	—	—
TR4F4050 B $\circ$				100-178	M10×1.5	16	35	25	8
TR4F4063 B $\circ$				100-179	M12×1.75	18	42	30	10
TR4F4080 BM- $\circ$				100-180	M16×2.0	24	51	35	14
TR4F4100 B $\circ$				100-178	M10×1.5	16	35	25	8
TR4F5063 B $\square$ -4	555-141	4.9	105-T20	100-179	M12×1.75	18	42	30	10
TR4F5080 BM-5				100-180	M16×2.0	24	51	35	14
TR4F5100 B $\square$ -6				—	—	—	—	—	—
TR4F5125 B $\square$				—	—	—	—	—	—

[Note] The clamp screw is a consumable part. Since replacement life depends on the use environment, it is recommended that it be replaced at an early stage. Includes one spare clamp screw for shank type and modular, two spare clamp screws for bore type.

# Bore type

# TR4F $\circ\circ\circ\circ\circ\circ$ B $\square$ - $\circ$

Numeric figure comes in a circle  $\circ$  and alphabetical character comes in a square  $\square$ .

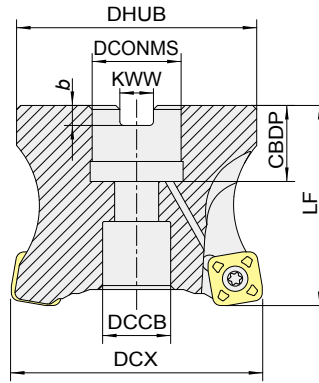

Fig.1 (With air hole)

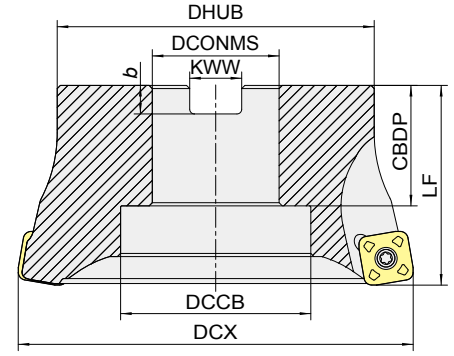

Fig.2 (With air hole)

Type	Item code	Stock	No. of flutes	Size (mm)								Shape	Recommended insert		
				DCX	DHUB	LF	CBDP	KWW	b	DCONMS	DCCB				
Bore type	Internal diameter inch size	TR4F4050B-3	●	3	50	47	50	19	8.4	5	22.225	17	Fig.1	SDNW120520TR(-P) SDMT120520TR	
		TR4F4050B-4	●	4											
		TR4F4050B-5	●	5											
		TR4F4063B-4	●	4											
		TR4F4063B-5	●	5	63	60	50	19	8.4	5	22.225	17			
		TR4F4063B-6	●	6											
		TR4F4080B-5	●	5											
		TR4F4080B-7	●	7	80	76	70	32	12.7	8	31.75	26			
		TR4F4100B-6	●	6											
		TR4F4100B-8	●	8	100	96	70	32	12.7	8	31.75	26			
		TR4F5063B-4	●	4											
		TR4F5080B-5	●	5	80	76	70	32	12.7	8	31.75	26			
		TR4F5100B-6	●	6											
		TR4F5125B-6	●	6											
	TR4F5125B-7	●	7	125	100	63	38	15.9	10	38.1	60	Fig.2	SDNW150525ZTR SDMT150525ZTR		
	TR4F4050BM-3	●	3												
Internal diameter mm size	TR4F4050BM-4	●	4	50	47	50	20	10.4	6.3	22	17	Fig.1	SDNW120520TR(-P) SDMT120520TR		
	TR4F4050BM-5	●	5												
	TR4F4063BM-4	●	4												
	TR4F4063BM-5	●	5												
	TR4F4063BM-6	●	6	63	60	50	20	10.4	6.3	22	17				
	TR4F4080BM-5	●	5												
	TR4F4080BM-7	●	7												
	TR4F4100BM-6	●	6	100	96	70	25.5	14.4	8	32	26				
	TR4F4100BM-8	●	8												
	TR4F5063BM-4	●	4	63	60	50	20	10.4	6.3	22	17				
	TR4F5080BM-5	●	5												
	TR4F5100BM-6	●	6												
	TR4F5125BM-6	●	6	125	100	63	38	16.4	9	40	60			Fig.2	SDNW150525ZTR SDMT150525ZTR
	TR4F5125BM-7	●	7												

[Note] Arbor screw is not included.

# Line Up

## Insert

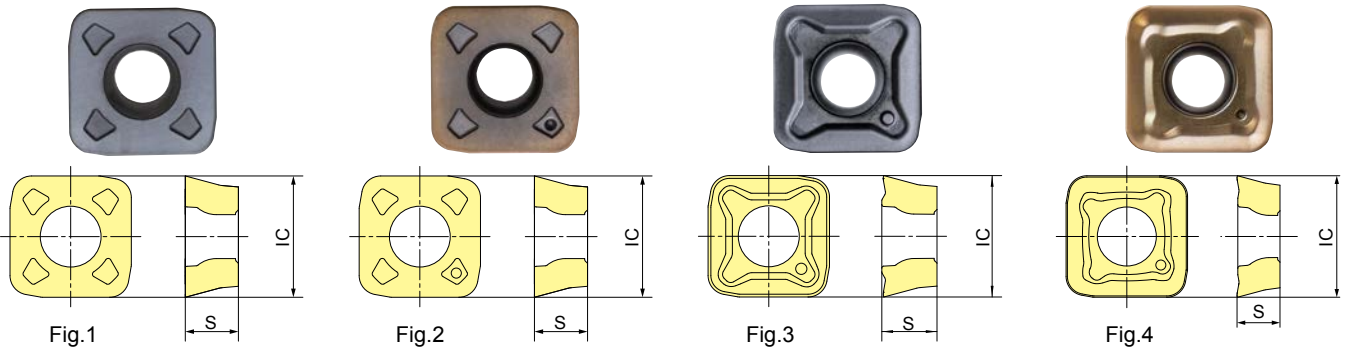

Item code	Tolerance class	AJ-Coating			JS-Coating	GX-Coating	Size (mm)		Shape
		JP4105	JP4120	JM4160	JS4060	GX2140	IC	S	
SDNW120520TR	N	●	●	●	●	●	12.7	5.56	Fig.1
SDNW120520TR-P		● <sup>*1</sup>							Fig.2
SDNW150525ZTR		●	●	●	●	●	15.875	Fig.1	
SDMT120520TR	M		●	●	●	●	12.7	5.76	Fig.3
SDMT150525ZTR			★	★	★	★	15.875	5.61	Fig.4

\* 1 : Can be used to process the precipitation hardening stainless steel.

[Note] Please note that the GX Coating and JS Coating do not cause a reaction in conductive touch sensors.

## Grade map for less than 35HRC

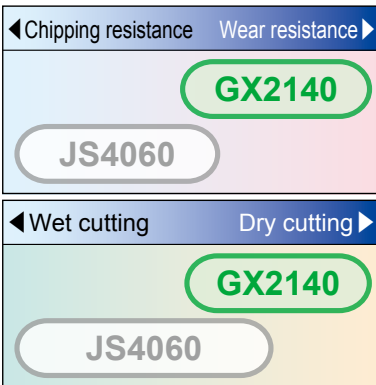

## Grade map for work materials

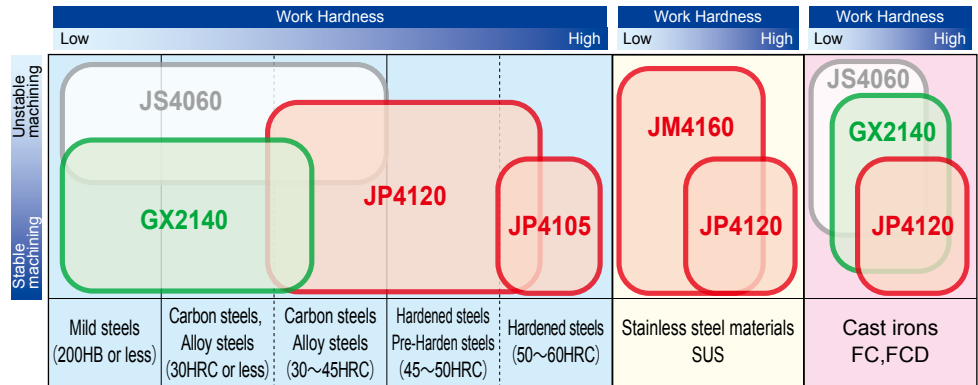

## Proper use of inserts

SDNW120520TR SDNW150525ZTR	SDNW120520TR-P	SDMT120520TR SDMT150525ZTR
The recommended default insert offers superior cutting edge strength. Ideal for general high-feed cutting.	Recommended for relatively continuous (uninterrupted) cutting with short overhangs. Ideal for pre-hardened steels (P20 and P21 materials).	Breaker type insert. Ideal for rough machining with low-rigidity work materials and low-horsepower M/C.

★ : Stocked items of new products. ● : Stocked items.



# Recommended Cutting Conditions

## ① Shank type / Modular type

TR4F4000type(TR4F40 $\odot$ S/M/L(32)- $\odot$ )  
Numeric figure in a circle  $\odot$

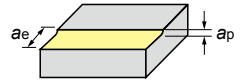

## ② Standard cutting conditions for contour roughing

Work material	Type	Recommended inserts grade	Tool dia. DCX	Shank Type				Modular Type				
				$\phi 32$ (2 Flutes)		$\phi 40$ (3 Flutes)		$\phi 32$ (2 Flutes)			$\phi 40$ (3 Flutes)	
				<3DCX		<3DCX		<3DCX		3DCX-5DCX	<3DCX	
Overhang		General purpose	High-speed Cutting	General purpose	High-speed Cutting	General purpose	High-speed Cutting		General purpose	High-speed Cutting		
Mild steels (200HB or less)	GX2140 JS4060	$n$ (min $^{-1}$ )	1490	1990	1190	1590	1490	1990	1490	1190	1590	1190
		$Vc$ (m/min)	150	200	150	200	150	200	150	150	200	150
		$Vf$ (mm/min)	5360	7960	6430	9540	5360	7960	5360	6430	9540	6430
		$fz$ (mm/t)	1.8	2.0	1.8	2.0	1.8	2.0	1.8	1.8	2.0	1.8
		$\hat{a}p$ (mm)	1.0	1.0	1.0	1.0	1.0	1.0	1.0	1.0	1.0	1.0
		$\hat{a}e$ (mm)	14	14	22	22	14	14	14	22	22	22
		$Q$ (cm $^3$ /min)	75	111	141	210	75	111	75	141	210	141
Carbon steels Alloy steels (35HRC or less)	GX2140 JS4060	$n$ (min $^{-1}$ )	1490	1990	1190	1590	1490	1990	1490	1190	1590	1190
		$Vc$ (m/min)	150	200	150	200	150	200	150	150	200	150
		$Vf$ (mm/min)	5360	7960	6430	9540	5360	7960	5360	6430	9540	6430
		$fz$ (mm/t)	1.8	2.0	1.8	2.0	1.8	2.0	1.8	1.8	2.0	1.8
		$\hat{a}p$ (mm)	1.0	1.0	1.0	1.0	1.0	1.0	1.0	1.0	1.0	1.0
		$\hat{a}e$ (mm)	14	14	22	22	14	14	14	22	22	22
		$Q$ (cm $^3$ /min)	75	111	141	210	75	111	75	141	210	141
Carbon steels Alloy steels (35 ~ 45HRC)	JP4120 JS4060	$n$ (min $^{-1}$ )	1290	1490	1030	1190	1290	1490	1290	1030	1190	1030
		$Vc$ (m/min)	130	150	130	150	130	150	130	130	150	130
		$Vf$ (mm/min)	4640	5960	5560	7140	4640	5960	4640	5560	7140	5560
		$fz$ (mm/t)	1.8	2.0	1.8	2.0	1.8	2.0	1.8	1.8	2.0	1.8
		$\hat{a}p$ (mm)	1.0	1.0	1.0	1.0	1.0	1.0	1.0	1.0	1.0	1.0
		$\hat{a}e$ (mm)	14	14	22	22	14	14	14	22	22	22
		$Q$ (cm $^3$ /min)	65	83	122	157	65	83	65	122	157	122
Stainless steels SUS	JM4160	$n$ (min $^{-1}$ )	990	1990	800	1590	990	1990	990	800	1590	800
		$Vc$ (m/min)	100	200	100	200	100	200	100	100	200	100
		$Vf$ (mm/min)	1980	3980	2400	4770	1980	3980	1980	2400	4770	2400
		$fz$ (mm/t)	1.0	1.0	1.0	1.0	1.0	1.0	1.0	1.0	1.0	1.0
		$\hat{a}p$ (mm)	1.0	1.0	1.0	1.0	1.0	1.0	1.0	1.0	1.0	1.0
		$\hat{a}e$ (mm)	14	14	22	22	14	14	14	22	22	22
		$Q$ (cm $^3$ /min)	28	56	53	105	28	56	28	53	105	53
Cast irons FC FCD	JP4120 GX2140	$n$ (min $^{-1}$ )	1490	1990	1190	1590	1490	1990	1490	1190	1590	1190
		$Vc$ (m/min)	150	200	150	200	150	200	150	150	200	150
		$Vf$ (mm/min)	5960	7960	7140	9540	5960	7960	5960	7140	9540	7140
		$fz$ (mm/t)	2.0	2.0	2.0	2.0	2.0	2.0	2.0	2.0	2.0	2.0
		$\hat{a}p$ (mm)	1.0	1.0	1.0	1.0	1.0	1.0	1.0	1.0	1.0	1.0
		$\hat{a}e$ (mm)	14	14	22	22	14	14	14	22	22	22
		$Q$ (cm $^3$ /min)	83	111	157	210	83	111	83	157	210	157
Hardened steels (45 ~ 50HRC)	JP4120 JP4105	$n$ (min $^{-1}$ )	800	900	640	720	800	900	800	640	720	640
		$Vc$ (m/min)	80	90	80	90	80	90	80	80	90	80
		$Vf$ (mm/min)	800	1440	960	1730	800	1440	800	960	1730	960
		$fz$ (mm/t)	0.5	0.8	0.5	0.8	0.5	0.8	0.5	0.5	0.8	0.5
		$\hat{a}p$ (mm)	0.8	0.8	0.8	0.8	0.8	0.8	0.8	0.8	0.8	0.8
		$\hat{a}e$ (mm)	14	14	22	22	14	14	14	22	22	22
		$Q$ (cm $^3$ /min)	9	16	17	30	9	16	9	17	30	17
Hardened steels (50 ~ 60HRC)	JP4105 JP4120	$n$ (min $^{-1}$ )	800	900	640	720	800	900	800	640	720	640
		$Vc$ (m/min)	80	90	80	90	80	90	80	80	90	80
		$Vf$ (mm/min)	640	1080	770	1300	640	1080	640	770	1300	770
		$fz$ (mm/t)	0.4	0.6	0.4	0.6	0.4	0.6	0.4	0.4	0.6	0.4
		$\hat{a}p$ (mm)	0.8	0.8	0.8	0.8	0.8	0.8	0.8	0.8	0.8	0.8
		$\hat{a}e$ (mm)	14	14	22	22	14	14	14	22	22	22
		$Q$ (cm $^3$ /min)	7	12	14	23	7	12	7	14	23	14

## ③ Standard cutting conditions for vertical roughing

Work material	Recommended inserts grade	Tool dia. DCX	$\phi 32$ (2 Flutes)		$\phi 40$ (3 Flutes)		
			Overhang	<3DCX	3DCX-5DCX	<3DCX	3DCX-5DCX
Cast irons FC FCD	JP4120 GX2140	$n$ (min $^{-1}$ )		1990	1990	1590	1590
		$Vc$ (m/min)		200	200	200	200
		$Vf$ (mm/min)		600	600	720	720
		$fz$ (mm/t)		0.15	0.15	0.15	0.15
		$\hat{a}p$ (mm)		$\leq 0.5DCX$		$\leq 0.5DCX$	
		$\hat{a}e$ (mm)		$\leq 9.0$		$\leq 9.0$	

[Note] ① This table provides general guidelines for cutting conditions; in actual machining conditions adjust the parameters according to your actual machine and work-piece conditions. In particular, when performing shoulder milling in combination with slotting or machining of cutting widths close to slots, etc., chattering vibrations may occur, which can lead to trouble. Therefore, please consider the following when adjusting the conditions;

- Reduce rotation speed and table feed rate by 50 to 70%
- Reduce cutting depth  $\hat{a}p$  by 50 to 70%
- Reduce cutting width  $\hat{a}e$  by 50 to 70%

② Please note that the GX Coating and JS Coating do not cause a reaction in conductive touch sensors.

③ JP4105 is for the high-hardness steels. It is not suitable for Non-heat-treated steel material.

④ For strongly interrupted cutting, when unsupported length is long, or for wet cutting, JM4160 is recommended.

⑤ To prevent tool damage due to chip clogging, always use a chip removal method such as an air blower, etc.

⑥ Since there is a danger of the removed chips flying out and causing injury to workers, fire, or damage to eyes, during use be sure to cover the work area with a safety cover and have workers wear protective equipment such as glasses, etc. to make the work area safe.

⑦ Perform insert replacement at an early stage to prevent chipping due to excessive use.

⑧ Use of the MOLDINO anti-vibration arbor is recommended for overhang of 5DCX or more.

⑨ The following equation can be used to determine the metal removal rate per unit time  $Q$ ;  $Q(\text{cm}^3/\text{min}) = \hat{a}p(\text{mm}) \times \hat{a}e(\text{mm}) \times Vf(\text{mm}/\text{min}) / 1000$

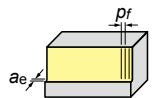

# Recommended Cutting Conditions

② Bore type TR4F4000 type (TR4F4050B , TR4F4063B ) Numeric figure in a circle  and Alphabetical character comes in a square .

## Standard cutting conditions for contour roughing

Work material	Recommended inserts grade	Tool dia. DCX	φ50 (3 Flutes)			φ50 (4 Flutes)			φ50 (5 Flutes)			
			Overhang	<3DCX		3DCX-5DCX	<3DCX		3DCX-5DCX	<3DCX		3DCX-5DCX
				General purpose	High-speed Cutting		General purpose	High-speed Cutting		General purpose	High-speed Cutting	
Mild steels (200HB or less)	GX2140 JS4060	n (min <sup>-1</sup> )	950	1270	950	950	1270	950	950	1270	950	
		Vc(m/min)	150	200	150	150	200	150	150	200	150	
		Vf(mm/min)	5130	7620	5130	6840	10160	6840	8550	12700	8550	
		fz(mm/t)	1.8	2.0	1.8	1.8	2.0	1.8	1.8	2.0	1.8	
		ap(mm)	1.0	1.0	1.0	1.0	1.0	1.0	1.0	1.0	1.0	
		ae(mm)	30	30	30	30	30	30	30	30	30	
		Q(cm <sup>3</sup> /min)	154	229	154	205	305	205	257	381	257	
Carbon steels Alloy steels (35HRC or less)	GX2140 JS4060	n (min <sup>-1</sup> )	950	1270	950	950	1270	950	950	1270	950	
		Vc(m/min)	150	200	150	150	200	150	150	200	150	
		Vf(mm/min)	5130	7620	5130	6840	10160	6840	8550	12700	8550	
		fz(mm/t)	1.8	2.0	1.8	1.8	2.0	1.8	1.8	2.0	1.8	
		ap(mm)	1.0	1.0	1.0	1.0	1.0	1.0	1.0	1.0	1.0	
		ae(mm)	30	30	30	30	30	30	30	30	30	
		Q(cm <sup>3</sup> /min)	154	229	154	205	305	205	257	381	257	
Carbon steels Alloy steels (35 ~ 45HRC)	JP4120 JS4060	n (min <sup>-1</sup> )	830	950	830	830	950	830	830	950	830	
		Vc(m/min)	130	150	130	130	150	130	130	150	130	
		Vf(mm/min)	4480	5700	4480	5980	7600	5980	7470	9500	7470	
		fz(mm/t)	1.8	2.0	1.8	1.8	2.0	1.8	1.8	2.0	1.8	
		ap(mm)	1.0	1.0	1.0	1.0	1.0	1.0	1.0	1.0	1.0	
		ae(mm)	30	30	30	30	30	30	30	30	30	
		Q(cm <sup>3</sup> /min)	134	171	134	179	228	179	224	285	224	
Stainless steels SUS	JM4160	n (min <sup>-1</sup> )	640	1270	640	640	1270	640	640	1270	640	
		Vc(m/min)	100	200	100	100	200	100	100	200	100	
		Vf(mm/min)	1920	3810	1920	2560	5080	2560	3200	6350	3200	
		fz(mm/t)	1.0	1.0	1.0	1.0	1.0	1.0	1.0	1.0	1.0	
		ap(mm)	1.0	1.0	1.0	1.0	1.0	1.0	1.0	1.0	1.0	
		ae(mm)	30	30	30	30	30	30	30	30	30	
		Q(cm <sup>3</sup> /min)	58	114	58	77	152	77	96	191	96	
Cast irons FC FCD	JP4120 GX2140	n (min <sup>-1</sup> )	950	1270	950	950	1270	950	950	1270	950	
		Vc(m/min)	150	200	150	150	200	150	150	200	150	
		Vf(mm/min)	5700	7620	5700	7600	10160	7600	9500	12700	9500	
		fz(mm/t)	2.0	2.0	2.0	2.0	2.0	2.0	2.0	2.0	2.0	
		ap(mm)	1.0	1.0	1.0	1.0	1.0	1.0	1.0	1.0	1.0	
		ae(mm)	30	30	30	30	30	30	30	30	30	
		Q(cm <sup>3</sup> /min)	171	229	171	228	305	228	285	381	285	
Hardened steels (45 ~ 50HRC)	JP4120 JP4105	n (min <sup>-1</sup> )	510	570	510	510	570	510	510	570	510	
		Vc(m/min)	80	90	80	80	90	80	80	90	80	
		Vf(mm/min)	770	1370	770	1020	1820	1020	1280	2280	1280	
		fz(mm/t)	0.5	0.8	0.5	0.5	0.8	0.5	0.5	0.8	0.5	
		ap(mm)	0.8	0.8	0.8	0.8	0.8	0.8	0.8	0.8	0.8	
		ae(mm)	30	30	30	30	30	30	30	30	30	
		Q(cm <sup>3</sup> /min)	18	33	18	24	44	24	31	55	31	
Hardened steels (50 ~ 60HRC)	JP4105 JP4120	n (min <sup>-1</sup> )	510	570	510	510	570	510	510	570	510	
		Vc(m/min)	80	90	80	80	90	80	80	90	80	
		Vf(mm/min)	610	1030	610	820	1370	820	1020	1710	1020	
		fz(mm/t)	0.4	0.6	0.4	0.4	0.6	0.4	0.4	0.6	0.4	
		ap(mm)	0.8	0.8	0.8	0.8	0.8	0.8	0.8	0.8	0.8	
		ae(mm)	30	30	30	30	30	30	30	30	30	
		Q(cm <sup>3</sup> /min)	15	25	15	20	33	20	24	41	24	

## Standard cutting conditions for vertical roughing

Work material	Recommended inserts grade	Tool dia. DCX	φ50 (3 Flutes)		φ50 (4 Flutes)		φ50 (5 Flutes)		
			Overhang	<3DCX	3DCX-5DCX	<3DCX	3DCX-5DCX	<3DCX	3DCX-5DCX
				≤ 0.5DCX		≤ 0.5DCX		≤ 0.5DCX	
Cast irons FC FCD	JP4120 GX2140	n (min <sup>-1</sup> )	1270	1270	1270	1270	1270	1270	
		Vc(m/min)	200	200	200	200	200	200	
		Vf(mm/min)	760	760	1020	1020	1270	1270	
		fz(mm/t)	0.2	0.2	0.2	0.2	0.2	0.2	
		ap(mm)	≤ 0.5DCX		≤ 0.5DCX		≤ 0.5DCX		
ae(mm)	≤ 9.0		≤ 9.0		≤ 9.0				

**[Note]** ① This table provides general guidelines for cutting conditions; in actual machining conditions adjust the parameters according to your actual machine and work-piece conditions. In particular, when performing shoulder milling in combination with slotting or machining of cutting widths close to slots, etc., chattering vibrations may occur, which can lead to trouble. Therefore, please consider the following when adjusting the conditions:

- Reduce rotation speed and table feed rate by 50 to 70%
- Reduce cutting depth  $a_p$  by 50 to 70%
- Reduce cutting width  $a_e$  by 50 to 70%

② Please note that the GX Coating and JS Coating do not cause a reaction in conductive touch sensors.

③ JP4105 is for the high-hardness steels. It is not suitable for Non-heat-treated steel material.

④ For strongly interrupted cutting, when unsupported length is long, or for wet cutting, JM4160 is recommended.

⑤ To prevent tool damage due to chip clogging, always use a chip removal method such as an air blower, etc.

⑥ Since there is a danger of the removed chips flying out and causing injury to workers, fire, or damage to eyes, during use be sure to cover the work area with a safety cover and have workers wear protective equipment such as glasses, etc. to make the work area safe.

⑦ Perform insert replacement at an early stage to prevent chipping due to excessive use.

⑧ Use of the MOLDINO anti-vibration arbor is recommended for overhang of 5DCX or more.

⑨ The following equation can be used to determine the metal removal rate per unit time  $Q$ ;  $Q(\text{cm}^3/\text{min}) = a_p(\text{mm}) \times a_e(\text{mm}) \times Vf(\text{mm}/\text{min}) / 1000$

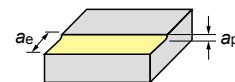

φ63(4 Flutes)			φ63(5 Flutes)			φ63(6 Flutes)			Work material
<3DCX		3DCX-5DCX	<3DCX		3DCX-5DCX	<3DCX		3DCX-5DCX	
General purpose	High-speed Cutting		General purpose	High-speed Cutting		General purpose	High-speed Cutting		
760	1010	760	760	1010	760	760	1010	760	Mild steels (200HB or less)
150	200	150	150	200	150	150	200	150	
5470	8080	5470	6840	10100	6840	8210	12120	8210	
1.8	2.0	1.8	1.8	2.0	1.8	1.8	2.0	1.8	
1.0	1.0	1.0	1.0	1.0	1.0	1.0	1.0	1.0	
44	44	44	44	44	44	44	44	44	
241	356	241	301	444	301	361	533	361	Carbon steels Alloy steels (35HRC or less)
760	1010	760	760	1010	760	760	1010	760	
150	200	150	150	200	150	150	200	150	
5470	8080	5470	6840	10100	6840	8210	12120	8210	
1.8	2.0	1.8	1.8	2.0	1.8	1.8	2.0	1.8	
1.0	1.0	1.0	1.0	1.0	1.0	1.0	1.0	1.0	
44	44	44	44	44	44	44	44	44	
241	356	241	301	444	301	361	533	361	Carbon steels Alloy steels (35 ~ 45HRC)
660	760	660	660	760	660	660	760	660	
130	150	130	130	150	130	130	150	130	
4750	6080	4750	5940	7600	5940	7130	9120	7130	
1.8	2.0	1.8	1.8	2.0	1.8	1.8	2.0	1.8	
1.0	1.0	1.0	1.0	1.0	1.0	1.0	1.0	1.0	
44	44	44	44	44	44	44	44	44	
209	268	209	261	334	261	314	401	314	Stainless steels SUS
510	1010	510	510	1010	510	510	1010	510	
100	200	100	100	200	100	100	200	100	
2040	4040	2040	2550	5050	2550	3060	6060	3060	
1.0	1.0	1.0	1.0	1.0	1.0	1.0	1.0	1.0	
1.0	1.0	1.0	1.0	1.0	1.0	1.0	1.0	1.0	
44	44	44	44	44	44	44	44	44	
90	178	90	112	222	112	135	267	135	Cast irons FC FCD
760	1010	760	760	1010	760	760	1010	760	
150	200	150	150	200	150	150	200	150	
6080	8080	6080	7600	10100	7600	9120	12120	9120	
2.0	2.0	2.0	2.0	2.0	2.0	2.0	2.0	2.0	
1.0	1.0	1.0	1.0	1.0	1.0	1.0	1.0	1.0	
44	44	44	44	44	44	44	44	44	
268	356	268	334	444	334	401	533	401	Hardened steels (45 ~ 50HRC)
400	450	400	400	450	400	400	450	400	
80	90	80	80	90	80	80	90	80	
800	1440	800	1000	1800	1000	1200	2160	1200	
0.5	0.8	0.5	0.5	0.8	0.5	0.5	0.8	0.5	
0.8	0.8	0.8	0.8	0.8	0.8	0.8	0.8	0.8	
44	44	44	44	44	44	44	44	44	
28	51	28	35	63	35	42	76	42	Hardened steels (50 ~ 60HRC)
400	450	400	400	450	400	400	450	400	
80	90	80	80	90	80	80	90	80	
640	1080	640	800	1350	800	960	1620	960	
0.4	0.6	0.4	0.4	0.6	0.4	0.4	0.6	0.4	
0.8	0.8	0.8	0.8	0.8	0.8	0.8	0.8	0.8	
44	44	44	44	44	44	44	44	44	
23	38	23	28	48	28	34	57	34	

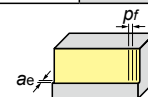



φ63(4 Flutes)		φ63(5 Flutes)		φ63(6 Flutes)		Work material
<3DCX	3DCX-5DCX	<3DCX	3DCX-5DCX	<3DCX	3DCX-5DCX	
1010	1010	1010	1010	1010	1010	
200	200	200	200	200	200	
810	810	1010	1010	1210	1210	
0.2	0.2	0.2	0.2	0.2	0.2	
≦ 0.5DCX		≦ 0.5DCX		≦ 0.5DCX		
≦ 9.0		≦ 9.0		≦ 9.0		

# Recommended Cutting Conditions

## ② Bore type

TR4F4000 type (TR4F4080B , TR4F4100B )

Numeric figure in a circle  and Alphabetical character comes in a square .

### ● Standard cutting conditions for contour roughing

Work material	Recommended inserts grade	Tool dia. DCX	φ80 (5 Flutes)			φ80 (7 Flutes)			
			Overhang	<3DCX		3DCX-5DCX	<3DCX		3DCX-5DCX
				General purpose	High-speed Cutting		General purpose	High-speed Cutting	
Mild steels (200HB or less)	GX2140 JS4060	$n$ (min <sup>-1</sup> )	600	800	600	600	800	600	
		$Vc$ (m/min)	150	200	150	150	200	150	
		$Vf$ (mm/min)	5400	8000	5400	7560	11200	7560	
		$fz$ (mm/t)	1.8	2.0	1.8	1.8	2.0	1.8	
		$ap$ (mm)	1.0	1.0	1.0	1.0	1.0	1.0	
		$ae$ (mm)	60	60	60	60	60	60	
		$Q$ (cm <sup>3</sup> /min)	324	480	324	454	672	454	
Carbon steels Alloy steels (35HRC or less)	GX2140 JS4060	$n$ (min <sup>-1</sup> )	600	800	600	600	800	600	
		$Vc$ (m/min)	150	200	150	150	200	150	
		$Vf$ (mm/min)	5400	8000	5400	7560	11200	7560	
		$fz$ (mm/t)	1.8	2.0	1.8	1.8	2.0	1.8	
		$ap$ (mm)	1.0	1.0	1.0	1.0	1.0	1.0	
		$ae$ (mm)	60	60	60	60	60	60	
		$Q$ (cm <sup>3</sup> /min)	324	480	324	454	672	454	
Carbon steels Alloy steels (35 ~ 45HRC)	JP4120 JS4060	$n$ (min <sup>-1</sup> )	520	600	520	520	600	520	
		$Vc$ (m/min)	130	150	130	130	150	130	
		$Vf$ (mm/min)	4680	6000	4680	6550	8400	6550	
		$fz$ (mm/t)	1.8	2.0	1.8	1.8	2.0	1.8	
		$ap$ (mm)	1.0	1.0	1.0	1.0	1.0	1.0	
		$ae$ (mm)	60	60	60	60	60	60	
		$Q$ (cm <sup>3</sup> /min)	281	360	281	393	504	393	
Stainless steels SUS	JM4160	$n$ (min <sup>-1</sup> )	400	800	400	400	800	400	
		$Vc$ (m/min)	100	200	100	100	200	100	
		$Vf$ (mm/min)	2000	4000	2000	2800	5600	2800	
		$fz$ (mm/t)	1.0	1.0	1.0	1.0	1.0	1.0	
		$ap$ (mm)	1.0	1.0	1.0	1.0	1.0	1.0	
		$ae$ (mm)	60	60	60	60	60	60	
		$Q$ (cm <sup>3</sup> /min)	120	240	120	168	336	168	
Cast irons FC FCD	JP4120 GX2140	$n$ (min <sup>-1</sup> )	600	800	600	600	800	600	
		$Vc$ (m/min)	150	200	150	150	200	150	
		$Vf$ (mm/min)	6000	8000	6000	8400	11200	8400	
		$fz$ (mm/t)	2.0	2.0	2.0	2.0	2.0	2.0	
		$ap$ (mm)	1.0	1.0	1.0	1.0	1.0	1.0	
		$ae$ (mm)	60	60	60	60	60	60	
		$Q$ (cm <sup>3</sup> /min)	360	480	360	504	672	504	
Hardened steels (45 ~ 50HRC)	JP4120 JP4105	$n$ (min <sup>-1</sup> )	320	360	320	320	360	320	
		$Vc$ (m/min)	80	90	80	80	90	80	
		$Vf$ (mm/min)	800	1440	800	1120	2020	1120	
		$fz$ (mm/t)	0.5	0.8	0.5	0.5	0.8	0.5	
		$ap$ (mm)	0.8	0.8	0.8	0.8	0.8	0.8	
		$ae$ (mm)	60	60	60	60	60	60	
		$Q$ (cm <sup>3</sup> /min)	38	69	38	54	97	54	
Hardened steels (50 ~ 60HRC)	JP4105 JP4120	$n$ (min <sup>-1</sup> )	320	360	320	320	360	320	
		$Vc$ (m/min)	80	90	80	80	90	80	
		$Vf$ (mm/min)	640	1080	640	900	1510	900	
		$fz$ (mm/t)	0.4	0.6	0.4	0.4	0.6	0.4	
		$ap$ (mm)	0.8	0.8	0.8	0.8	0.8	0.8	
		$ae$ (mm)	60	60	60	60	60	60	
		$Q$ (cm <sup>3</sup> /min)	31	52	31	43	72	43	

### ● Standard cutting conditions for vertical roughing

Work material	Recommended inserts grade	Tool dia. DCX	φ80 (5 Flutes)		φ80 (7 Flutes)		
			Overhang	<3DCX	3DCX-5DCX	<3DCX	3DCX-5DCX
Cast irons FC FCD	JP4120 GX2140	$n$ (min <sup>-1</sup> )	800	800	800	800	
		$Vc$ (m/min)	200	200	200	200	
		$Vf$ (mm/min)	800	800	1120	1120	
		$fz$ (mm/t)	0.2	0.2	0.2	0.2	
		$pf$ (mm)	≤ 0.5DCX		≤ 0.5DCX		
		$ae$ (mm)	≤ 9.0		≤ 9.0		

**[Note]** ① This table provides general guidelines for cutting conditions; in actual machining conditions adjust the parameters according to your actual machine and work-piece conditions. In particular, when performing shoulder milling in combination with slotting or machining of cutting widths close to slots, etc., chattering vibrations may occur, which can lead to trouble. Therefore, please consider the following when adjusting the conditions:

- Reduce rotation speed and table feed rate by 50 to 70%
- Reduce cutting depth  $ap$  by 50 to 70%
- Reduce cutting width  $ae$  by 50 to 70%

② Please note that the GX Coating and JS Coating do not cause a reaction in conductive touch sensors.

③ JP4105 is for the high-hardness steels. It is not suitable for Non-heat-treated steel material.

④ For strongly interrupted cutting, when unsupported length is long, or for wet cutting, JM4160 is recommended.

⑤ To prevent tool damage due to chip clogging, always use a chip removal method such as an air blower, etc.

⑥ Since there is a danger of the removed chips flying out and causing injury to workers, fire, or damage to eyes, during use be sure to cover the work area with a safety cover and have workers wear protective equipment such as glasses, etc. to make the work area safe.

⑦ Perform insert replacement at an early stage to prevent chipping due to excessive use.

⑧ Use of the MOLDINO anti-vibration arbor is recommended for overhang of 5DCX or more.

⑨ The following equation can be used to determine the metal removal rate per unit time  $Q$ :  $Q(\text{cm}^3/\text{min}) = ap(\text{mm}) \times ae(\text{mm}) \times Vf(\text{mm}/\text{min}) / 1000$

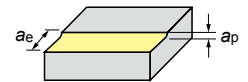

$\phi 100$ (6 Flutes)			$\phi 100$ (8 Flutes)			Work material
<3DCX		3DCX-5DCX	<3DCX		3DCX-5DCX	
General purpose	High-speed Cutting		General purpose	High-speed Cutting		
480	640	480	480	640	480	Mild steels (200HB or less)
150	200	150	150	200	150	
5180	7680	5180	6910	10240	6910	
1.8	2.0	1.8	1.8	2.0	1.8	
1.0	1.0	1.0	1.0	1.0	1.0	
80	80	80	80	80	80	
414	614	414	553	819	553	Carbon steels Alloy steels (35HRC or less)
480	640	480	480	640	480	
150	200	150	150	200	150	
5180	7680	5180	6910	10240	6910	
1.8	2.0	1.8	1.8	2.0	1.8	
1.0	1.0	1.0	1.0	1.0	1.0	
80	80	80	80	80	80	
414	614	414	553	819	553	Carbon steels Alloy steels (35 ~ 45HRC)
410	480	410	410	480	410	
130	150	130	130	150	130	
4430	5760	4430	5900	7680	5900	
1.8	2.0	1.8	1.8	2.0	1.8	
1.0	1.0	1.0	1.0	1.0	1.0	
80	80	80	80	80	80	
354	461	354	472	614	472	Stainless steels SUS
320	640	320	320	640	320	
100	200	100	100	200	100	
1920	3840	1920	2560	5120	2560	
1.0	1.0	1.0	1.0	1.0	1.0	
1.0	1.0	1.0	1.0	1.0	1.0	
80	80	80	80	80	80	
154	307	154	205	410	205	Cast irons FC FCD
480	640	480	480	640	480	
150	200	150	150	200	150	
5760	7680	5760	7680	10240	7680	
2.0	2.0	2.0	2.0	2.0	2.0	
1.0	1.0	1.0	1.0	1.0	1.0	
80	80	80	80	80	80	
461	614	461	614	819	614	Hardened steels (45 ~ 50HRC)
250	290	250	250	290	250	
80	90	80	80	90	80	
750	1390	750	1000	1860	1000	
0.5	0.8	0.5	0.5	0.8	0.5	
0.8	0.8	0.8	0.8	0.8	0.8	
80	80	80	80	80	80	
48	89	48	64	119	64	Hardened steels (50 ~ 60HRC)
250	290	250	250	290	250	
80	90	80	80	90	80	
600	1040	600	800	1390	800	
0.4	0.6	0.4	0.4	0.6	0.4	
0.8	0.8	0.8	0.8	0.8	0.8	
80	80	80	80	80	80	
38	67	38	51	89	51	

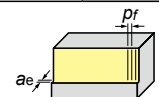

$\phi 100$ (6 Flutes)		$\phi 100$ (8 Flutes)		Work material
<3DCX	3DCX-5DCX	<3DCX	3DCX-5DCX	
640	640	640	640	
200	200	200	200	
770	770	1020	1020	
0.2	0.2	0.2	0.2	
$\leq 0.5DCX$		$\leq 0.5DCX$		
$\leq 9.0$		$\leq 9.0$		

# Recommended Cutting Conditions

## ② Bore type TR4F5000 type (TR4F5○○○○B□-○)

Numeric figure in a circle ○ and Alphabetical character comes in a square □.

### ○ Standard cutting conditions for contour roughing

Work material	Recommended inserts grade	Tool dia. DCX	φ63 (4 Flutes)			φ80 (5 Flutes)			
			Overhang	<3DCX		3DCX-5DCX	<3DCX		3DCX-5DCX
				General purpose	High efficiency		General purpose	High efficiency	
Mild steels (200HB or less)	GX2140 JS4060	n (min <sup>-1</sup> )	760	910	760	600	720	600	
		Vc(m/min)	150	180	150	150	180	150	
		Vf(mm/min)	4560	7280	5470	4500	7200	5400	
		fz(mm/t)	1.5	2.0	1.8	1.5	2.0	1.8	
		ap(mm)	2.0	2.0	1.0	2.0	2.0	1.0	
		ae(mm)	38	38	38	56	56	56	
		Q(cm <sup>3</sup> /min)	347	553	208	504	806	302	
Carbon steels Alloy steels (35HRC or less)	GX2140 JS4060	n (min <sup>-1</sup> )	760	910	760	600	720	600	
		Vc(m/min)	150	180	150	150	180	150	
		Vf(mm/min)	4560	7280	5470	4500	7200	5400	
		fz(mm/t)	1.5	2.0	1.8	1.5	2.0	1.8	
		ap(mm)	2.0	2.0	1.0	2.0	2.0	1.0	
		ae(mm)	38	38	38	56	56	56	
		Q(cm <sup>3</sup> /min)	347	553	208	504	806	302	
Carbon steels Alloy steels (35 ~ 45HRC)	JP4120 JS4060	n (min <sup>-1</sup> )	660	760	660	520	600	520	
		Vc(m/min)	130	150	130	130	150	130	
		Vf(mm/min)	4750	6080	4750	4680	6000	4680	
		fz(mm/t)	1.8	2.0	1.8	1.8	2.0	1.8	
		ap(mm)	1.5	1.5	1.0	1.5	1.5	1.0	
		ae(mm)	38	38	38	56	56	56	
		Q(cm <sup>3</sup> /min)	271	347	181	393	504	262	
Stainless steels SUS	JM4160	n (min <sup>-1</sup> )	510	1010	510	400	800	400	
		Vc(m/min)	100	200	100	100	200	100	
		Vf(mm/min)	2040	4040	2040	2000	4000	2000	
		fz(mm/t)	1.0	1.0	1.0	1.0	1.0	1.0	
		ap(mm)	1.5	1.5	1.0	1.5	1.5	1.0	
		ae(mm)	38	38	38	56	56	56	
		Q(cm <sup>3</sup> /min)	116	230	78	168	336	112	
Cast irons FC FCD	JP4120 GX2140	n (min <sup>-1</sup> )	760	910	760	600	720	600	
		Vc(m/min)	150	180	150	150	180	150	
		Vf(mm/min)	6080	8370	6080	6000	8280	6000	
		fz(mm/t)	2.0	2.3	2.0	2.0	2.3	2.0	
		ap(mm)	2.0	2.0	2.0	2.0	2.0	2.0	
		ae(mm)	38	38	38	56	56	56	
		Q(cm <sup>3</sup> /min)	462	636	462	672	927	672	
Hardened steels (45 ~ 50HRC)	JP4120 JP4105	n (min <sup>-1</sup> )	400	450	400	320	360	320	
		Vc(m/min)	80	90	80	80	90	80	
		Vf(mm/min)	800	1440	800	800	1440	800	
		fz(mm/t)	0.5	0.8	0.5	0.5	0.8	0.5	
		ap(mm)	1.0	1.0	1.0	1.0	1.0	1.0	
		ae(mm)	38	38	38	56	56	56	
		Q(cm <sup>3</sup> /min)	30	55	30	45	81	45	
Hardened steels (50 ~ 60HRC)	JP4105 JP4120	n (min <sup>-1</sup> )	400	450	400	320	360	320	
		Vc(m/min)	80	90	80	80	90	80	
		Vf(mm/min)	640	1080	640	640	1080	640	
		fz(mm/t)	0.4	0.6	0.4	0.4	0.6	0.4	
		ap(mm)	1.0	1.0	1.0	1.0	1.0	1.0	
		ae(mm)	38	38	38	56	56	56	
		Q(cm <sup>3</sup> /min)	24	41	24	36	60	36	

### ○ Standard cutting conditions for vertical roughing

Work material	Recommended inserts grade	Tool dia. DCX	φ63 (4 Flutes)		φ80 (5 Flutes)		
			Overhang	<3DCX	3DCX-5DCX	<3DCX	3DCX-5DCX
Cast irons FC FCD	JP4120 GX2140	n (min <sup>-1</sup> )		1010		800	
		Vc(m/min)		200		200	
		Vf(mm/min)		810		800	
		fz(mm/t)		0.2		0.2	
		pf(mm)		≤ 0.5DCX		≤ 0.5DCX	
		ae(mm)		≤ 11.0		≤ 11.0	

**[Note]** ① This table provides general guidelines for cutting conditions; in actual machining conditions adjust the parameters according to your actual machine and work-piece conditions. In particular, when performing shoulder milling in combination with slotting or machining of cutting widths close to slots, etc., chattering vibrations may occur, which can lead to trouble. Therefore, please consider the following when adjusting the conditions;

- Reduce rotation speed and table feed rate by 50 to 70%
- Reduce cutting depth  $a_p$  by 50 to 70%
- Reduce cutting width  $a_e$  by 50 to 70%
- ② If the machine has insufficient power, first try reducing the cutting depth. Next, try reducing the rotation speed and table feed rate.
- ③ Please note that the GX Coating and JS Coating do not cause a reaction in conductive touch sensors.
- ④ JP4105 is for the high-hardness steels. It is not suitable for Non-heat-treated steel material.
- ⑤ For strongly interrupted cutting, when unsupported length is long, or for wet cutting, JM4160 is recommended.
- ⑥ To prevent tool damage due to chip clogging, always use a chip removal method such as an air blower, etc.
- ⑦ Since there is a danger of the removed chips flying out and causing injury to workers, fire, or damage to eyes, during use be sure to cover the work area with a safety cover and have workers wear protective equipment such as glasses, etc. to make the work area safe.
- ⑧ Perform insert replacement at an early stage to prevent chipping due to excessive use.
- ⑨ Use of the MOLDINO anti-vibration arbor is recommended for overhang of 5DCX or more.
- ⑩ The following equation can be used to determine the metal removal rate per unit time Q:  $Q(\text{cm}^3/\text{min}) = a_p(\text{mm}) \times a_e(\text{mm}) \times Vf(\text{mm}/\text{min}) / 1000$

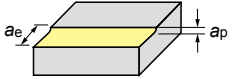

※ To ensure high-efficiency conditions, we recommend checking the machine's power/torque chart and using a rotation speed that can maintain the rated power of the spindle.

φ100(6 Flutes)			φ125(6 Flutes)			φ125(7 Flutes)			Work material
<3DCX		3DCX-5DCX	<3DCX		3DCX-5DCX	<3DCX		3DCX-5DCX	
General purpose	High efficiency		General purpose	High efficiency		General purpose	High efficiency		
480	570	480	380	460	380	380	460	380	Mild steels (200HB or less)
150	180	150	150	180	150	150	180	150	
4320	6840	5180	3420	5520	4100	3990	6440	4790	
1.5	2.0	1.8	1.5	2.0	1.8	1.5	2.0	1.8	
2.0	2.0	1.0	2.0	2.0	1.0	2.0	2.0	1.0	
75	75	75	100	100	100	100	100	100	
648	1026	389	684	1104	410	798	1288	479	
480	570	480	380	460	380	380	460	380	Carbon steels Alloy steels (35HRC or less)
150	180	150	150	180	150	150	180	150	
4320	6840	5180	3420	5520	4100	3990	6440	4790	
1.5	2.0	1.8	1.5	2.0	1.8	1.5	2.0	1.8	
2.0	2.0	1.0	2.0	2.0	1.0	2.0	2.0	1.0	
75	75	75	100	100	100	100	100	100	
648	1026	389	684	1104	410	798	1288	479	
410	480	410	330	380	330	330	380	330	Carbon steels Alloy steels (35 ~ 45HRC)
130	150	130	130	150	130	130	150	130	
4430	5760	4430	3560	4560	3560	4160	5320	4160	
1.8	2.0	1.8	1.8	2.0	1.8	1.8	2.0	1.8	
1.5	1.5	1.0	1.5	1.5	1.0	1.5	1.5	1.0	
75	75	75	100	100	100	100	100	100	
498	648	332	534	684	356	624	798	416	
320	640	320	250	510	250	250	510	250	Stainless steels SUS
100	200	100	100	200	100	100	200	100	
1920	3840	1920	1500	3060	1500	1750	3570	1750	
1.0	1.0	1.0	1.0	1.0	1.0	1.0	1.0	1.0	
1.5	1.5	1.0	1.5	1.5	1.0	1.5	1.5	1.0	
75	75	75	100	100	100	100	100	100	
216	432	144	225	459	150	263	536	175	
480	570	480	380	460	380	380	460	380	Cast irons FC FCD
150	180	150	150	180	150	150	180	150	
5760	7870	5760	4560	6350	4560	5320	7410	5320	
2.0	2.3	2.0	2.0	2.3	2.0	2.0	2.3	2.0	
2.0	2.0	2.0	2.0	2.0	2.0	2.0	2.0	2.0	
75	75	75	100	100	100	100	100	100	
864	1181	864	912	1270	912	1064	1482	1064	
250	290	250	200	230	200	200	230	200	Hardened steels (45 ~ 50HRC)
80	90	80	80	90	80	80	90	80	
750	1390	750	600	1100	600	700	1290	700	
0.5	0.8	0.5	0.5	0.8	0.5	0.5	0.8	0.5	
1.0	1.0	1.0	1.0	1.0	1.0	1.0	1.0	1.0	
75	75	75	100	100	100	100	100	100	
56	104	56	60	110	60	70	129	70	
250	290	250	200	230	200	200	230	200	Hardened steels (50 ~ 60HRC)
80	90	80	80	90	80	80	90	80	
600	1040	600	480	830	480	560	970	560	
0.4	0.6	0.4	0.4	0.6	0.4	0.4	0.6	0.4	
1.0	1.0	1.0	1.0	1.0	1.0	1.0	1.0	1.0	
75	75	75	100	100	100	100	100	100	
45	78	45	48	83	48	56	97	56	

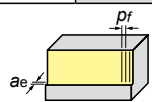

φ100(6 Flutes)		φ125(6 Flutes)		φ125(7 Flutes)		Work material
<3DCX	3DCX-5DCX	<3DCX	3DCX-5DCX	<3DCX	3DCX-5DCX	
640	640	510	510	510	510	
200	200	200	200	200	200	
770	770	610	610	710	710	
0.2	0.2	0.2	0.2	0.2	0.2	
≦ 0.5DCX		≦ 0.5DCX		≦ 0.5DCX		
≦ 11.0		≦ 11.0		≦ 11.0		

# Precautions for use

## ○ Programming R and maximum cutting depth

- Please define the tool shape in the CAM as indicated in the following table:

Insert	Programming R	Remains (mm)	Maximum cutting depth (mm)
SDNW120520TR(-P) SDMT120520TR	R3.0	1.0	1.2
SDNW150525ZTR SDMT150525ZTR	R3.0	1.47	2.0
	R4.0	1.32	

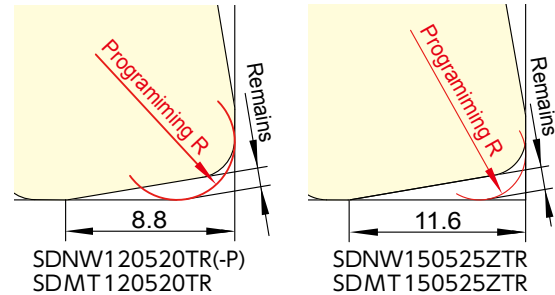

## ○ Maximum ramp angle and helical hole diameter

- Since the cutting flute do not extend to the center, there are limitations on the ramp angle and hole diameter, but as shown below, cutting by direct milling without a pilot hole is possible for ramping and helical milling.

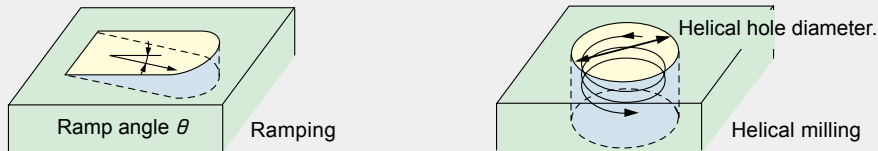

- For ramping and helical cutting, please set the “Vf” to around 50% of recommended cutting condition.

Inserts		Modular/ Shank Type		Bore Type							
		SDNW120520TR(-P) SDMT120520TR				SDNW150525ZTR / SDMT150525ZTR					
Tool dia. DCX (mm)		φ 32	φ 40	φ 50	φ 63	φ 80	φ 100	φ 63	φ 80	φ 100	φ 125
Ramping	Maximum ramp angle $\theta$	1°	1.4°	2°	2°	1.5°	1°	3°	2°	1.5°	1°
	Recommendation	1°						2°	1°		0.5°
Helical milling	Helical hole diameter	46 ~ 60	62 ~ 76	82 ~ 96	108 ~ 122	142 ~ 156	182 ~ 196	102 ~ 121	136 ~ 155	176 ~ 195	226 ~ 245

- [Note] ① The ramp angle  $\theta$  should be set within the ranges listed above. Do not exceed the recommended value.  
 ② For hole diameters outside the ranges listed above, a pilot hole should be drilled before milling.  
 ③ It is recommended that the tool be used while performing sufficient chip removal and checking that there are no abnormal vibrations.

## ○ Attention for the corner change

- Turn the insert counterclockwise upon corner change.

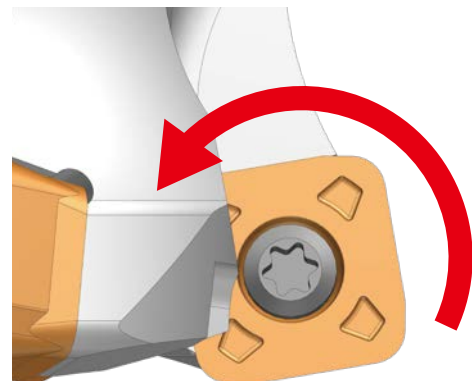



# Cutting performance

## Tool life curve with pre-hardened steels (40 HRC)

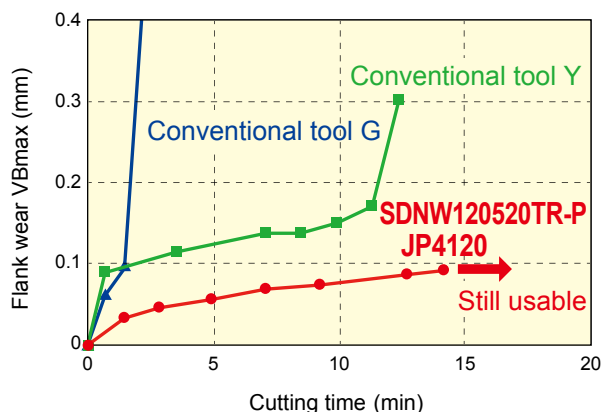

### Cutting Conditions

Work material	Pre-hardened steels (40HRC)
Tool	TR4F4063BM-5
Insert model	SDNW120520TR-P : JP4120
Cutting speed	$v_c = 140\text{m/min}$
Feed per tooth	$f_z = 2.0\text{mm/t}$
Cutting depth	$a_p \times a_e = 1.0 \times 45\text{mm}$
Overhang	200mm
Air-blow	Single flute cutting

Surpasses life of conventional tools for high-feed cutting at  $f_z=2.0\text{mm/t}$ .

## Tool life curve with quench-tempered steels (52 HRC)

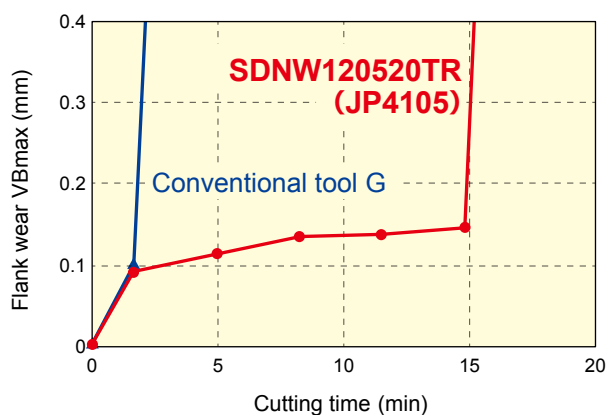

### Cutting Conditions

Work material	Quench-tempered steels (52 HRC) *Equivalent to SUS420J2
Tool	TR4F4063BM-5
Insert model	SDNW120520TR : JP4105
Cutting speed	$v_c = 90\text{m/min}$
Feed per tooth	$f_z = 1.0\text{mm/t}$
Cutting depth	$a_p \times a_e = 1.0 \times 35\text{mm}$
Overhang	200mm
Air-blow	Single flute cutting

Surpasses life of conventional tools for more efficient cutting of high-hardness materials

## Comparison of cutting force

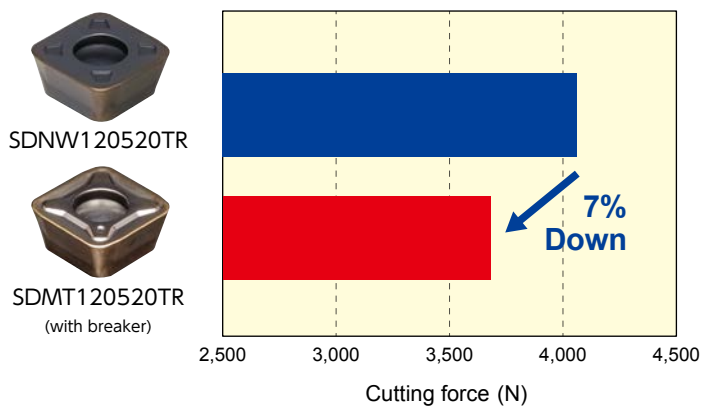

(Resultant force ; summation of the each component's maximum value)

### Cutting Conditions

Work material	Pre-hardened steels (32HRC)
Tool	TR4F4063BM-5
Insert model	SDNW120520TR : JP4120 SDMT120520TR : JP4120
Cutting speed	$v_c = 150\text{m/min}$
Feed per tooth	$f_z = 1.5\text{mm/t}$
Cutting depth	$a_p \times a_e = 1.0 \times 42\text{mm}$
Overhang	200mm
Air-blow	Single flute cutting

# Correspondence map for high-feed tools of mid/

## Our high-feed tools correspondence map (mid/large diameter)

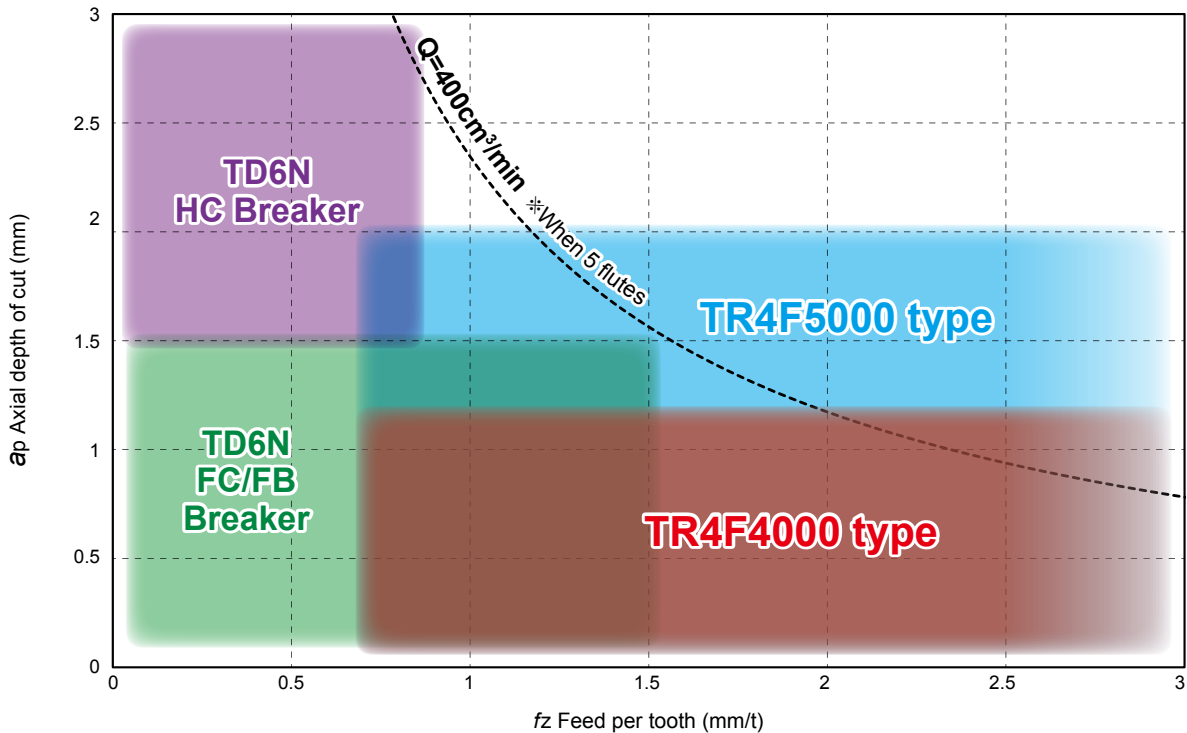

Work material : S50C(220HB), Machine : 3-axis MC vertical type (BT50,22kw)  
 Tool dia. :  $\phi 63$ , Cutting speed : 150m/min, Overhang :  $\leq 3\text{DCX}$

### TR4F type

Tool dia. :  
 $\phi 32 \sim 125$

No. of flutes :  
 2-8 Flutes



- Corresponds to high-feed cutting exceeding  $f_z = 2.0$  mm/t, with economical four-corners insert.
- Multi-purpose type capable of both vertical and contour cutting

### TD6N type

Tool dia. :  
 $\phi 50 \sim 125$

No. of flutes :  
 3-8 Flutes



- Lineup of high-feed type (FC/FB) and high depth type (HC) for inserts
- General-purpose type allows attachment of two types of inserts to one body to meet a broad range of cutting needs

# large diameter

## High-feed tools lineup

Type	Feature				Holder Tool dia. (mm)	Insert			Programming R (mm)	APMX (mm)
	Economical (No. of corners)	High accuracy (Less uncut remnants)	Supports for high-hardened steel	Efficiency (No. of Flutes)		No. of corners	Shape	Inscribed circle code		
TD4N 	◎	◎	○ ~62HRC	◎ High Efficiency multiflutes	φ16~40	4		06	2.0	1.0
ASR Multi-Flutes 		○	○ ~62HRC	◎ High Efficiency multiflutes	φ16~66	2		06	2.0	1.5
								12	3.0	2.0
ASRF mini 	◎		○ ~62HRC	○ General	φ20~63	4		07	2.0	1.2
ASR 		○	○ ~60HRC	○ General	φ20~100	2		08~15	3.0	2.0
ASRT 	○	○	○ ~62HRC	○ General	φ25~100	3		09~14		
ASRF 	◎		○ ~60HRC	○ General	φ32~100	4		12	4.5	
TD6N 	◎	○	~50HRC	○ General	φ50~125	6		14	3.0	1.5
										14
TR4F 	◎		○ ~60HRC	○ General	φ32~125	4		12	3.0	1.2
								15		2.0

Various other tools for roughing are also available.

For more information on tool specifications, please refer to our general catalog or visit our website. (<http://www.moldino.com>)



The diagrams and table data are examples of test results, and are not guaranteed values.  
 "MOLDINO" is a registered trademark of MOLDINO Tool Engineering, Ltd.



## Attentions on Safety

### 1. Handling

- (1) When removing tool from packaging, be careful not to drop the tool on your foot or fingers.
- (2) When actually setting the inserts, be careful not to touch the cutting flute directly with your bare hands.

### 2. Mounting

- (1) When preparing to use, be sure that the insert is firmly screwed in the pocket and cutter is properly mounted on the tool holder.
- (2) If abnormal chattering occurs during use, stop the machine immediately, identify the cause of the chatter and take corrective action.

### 3. Usage

- (1) Before use confirm all dimensions, verify work material and programmed tool rotation.
- (2) The numerical values in the standard cutting conditions table should be used as criteria when starting new work. The cutting conditions should be adjusted as appropriate when the cutting depth is large, the rigidity of the machine being used is low, or according to the conditions of the work material.
- (3) Inserts are made of hard material and may break and be expelled from cutter at high speeds. Since there is a danger of injury to workers from chip evacuation, insert breakage or fire safety precautions must be observed at all times. Including, but not limited to: safety glasses, machine enclosures or other means to create a safe environment for work. If you have questions on safety, contact your supervisor.
  - Do not use where there is a risk of fire or explosion.
  - Do not use non-water-soluble cutting oils. Such oils may result in fire.
- (4) Do not use the tool for any purpose other than that for which it is intended, and do not modify it.

## MOLDINO Tool Engineering, Ltd.

Head Office  
 Hulic Ryogoku Bldg. 8F, 4-31-11, Ryogoku, Sumida-ku, Tokyo, Japan 130-0026  
 International Sales Dept. : TEL +81-3-6890-5103 FAX +81-3-6890-5128

Official Web Site

<http://www.moldino.com/en/>

Database for selection Cutting Tool Products [TOOL SEARCH]



Europe

#### MOLDINO Tool Engineering Europe GmbH

Itterpark 12, 40724 Hilden, Germany  
 Tel +49-(0)2103-24820 Fax +49-(0)2103-248230

China

#### MOLDINO Tool Engineering (Shanghai), Ltd.

Room 2804-2805, Metro Plaza, 555 Loushanguan Road, Changning District, Shanghai, 200051, China  
 Tel +86-(0)21-3366-3058 Fax +86-(0)21-3366-3050

America

#### MITSUBISHI MATERIALS U.S.A. CORPORATION

DETROIT OFFICE Customer service  
 41700 Gardenbrook Road, Suite 120, Novi, MI 48375-1320 U.S.A.  
 Tel +1(248) 308-2620 Fax +1(248) 308-2627

Mexico

#### MMC METAL DE MEXICO, S.A. DE C.V.

Av. La Cañada No.16, Parque Industrial Bernardo Quintana, El Marques, Querétaro, CP 76246, México  
 Tel +52-442-1928600

Brazil

#### MMC METAL DO BRASIL LTDA.

Rua Cincinnati Braga, 340 13° andar, Bela Vista – CEP 01333-010 São Paulo – SP., Brasil  
 Tel +55(11)3506-5600 Fax +55(11)3506-5677

Thailand

#### MMC Hardmetal (Thailand) Co.,Ltd. MOLDINO Division

622 Emporium Tower, Floor 22/1-4, Sukhumvit Road, Klong Tan, Klong Toei,  
 Bangkok 10110, Thailand  
 Tel +66-(0)2-661-8175 Fax +66-(0)2-661-8176

India

#### MMC Hardmetal India Pvt Ltd.

H.O.: Prasad Enclave, #118/119, 1st Floor, 2nd Stage, 5th main, BBMP Ward #11, (New #38),  
 Industrial Suburb, Yeshwanthpura, Bengaluru, 560 022, Karnataka, India.  
 Tel +91-80-2204-3600

DISTRIBUTED BY: