

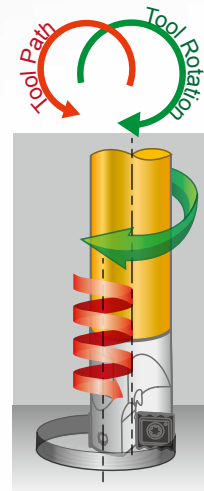

# NC Helix Drill

## One Tool Performs Multiple Applications

Rough Milling,  
Drilling & Slotting



All NC Helix Drill must be programmed by helical interpolation

### Reduce Your Tool Inventory

**Only four tools for making  $\text{\O}13\sim\text{\O}65\text{mm}$  hole from solid.**

Each holder can machine different diameters and hole depths, saving your tool inventory and cost!

No need to peck drill or dwell in operation even machine without internal coolant.

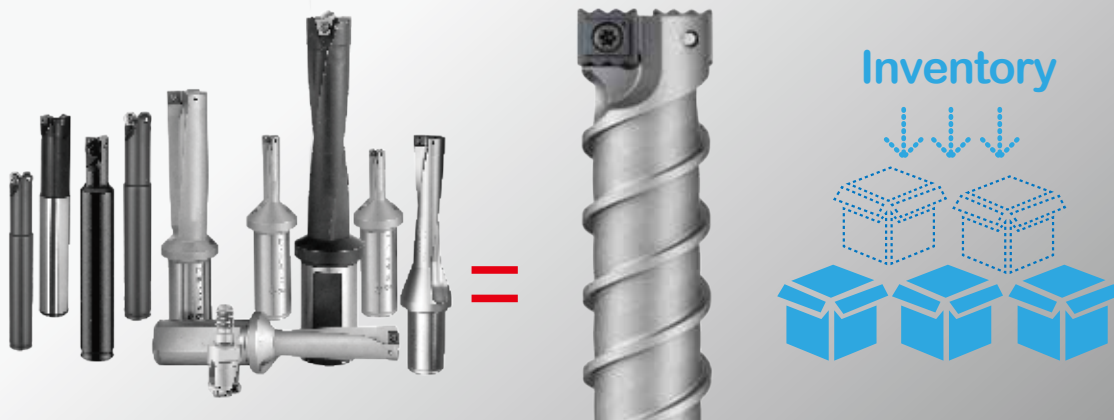

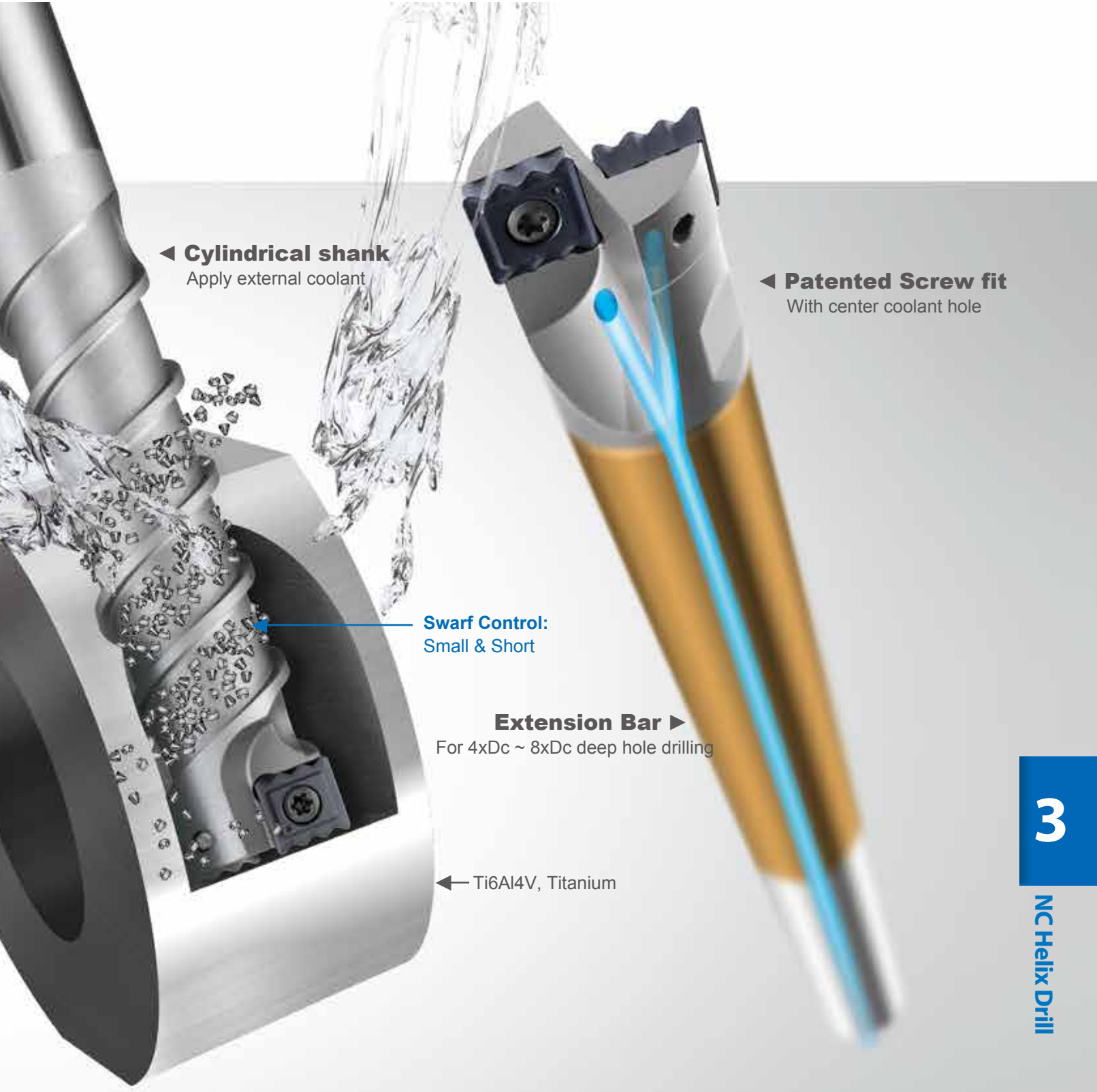

◀ **Cylindrical shank**  
Apply external coolant

◀ **Patented Screw fit**  
With center coolant hole

→ **Swarf Control:**  
Small & Short

**Extension Bar ▶**  
For 4xDc ~ 8xDc deep hole drilling

← Ti6Al4V, Titanium

**3**

**NC Helix Drill**

**20° Ramping Angle**  
Either linear or circular ramping.

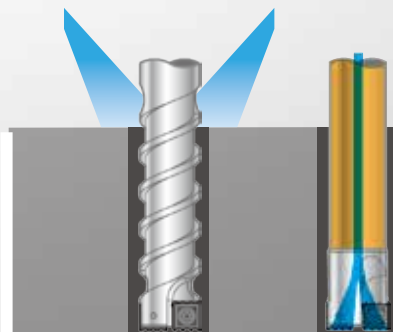

**Two types of shank**  
Drilling depth up to 8xDc

20°

# 01

Feature

## Lower spindle power consumption Easy to cut!

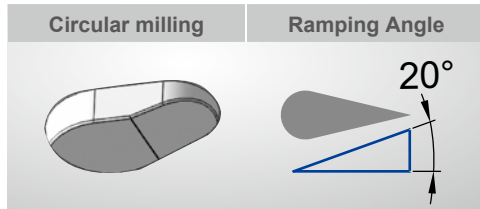

- Thanks to the small cutting load of the serrated cutting edge and helical interpolation lower power consumption. Work quicker, smarter and achieve better results.
- Circular ramping milling, maximum ramping angle is 20°.  
For example: tool HD27 machining Ø50 mm hole, 9 mm pitch for aluminum, 6 mm pitch for carbon steel.

# 02

Feature

## Just four tools for drilling Ø13~Ø65 mm or larger

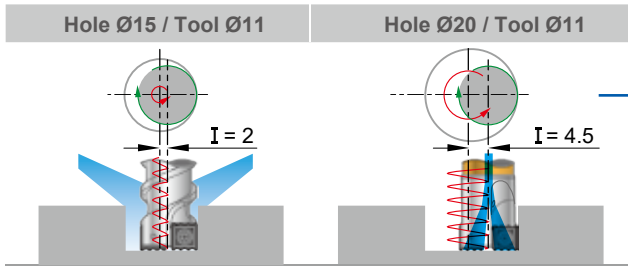

Example :

- Cuts by helical interpolation.
- Each holder can machine different diameters and hole depths.
- Enlarger hole is adaptable by using 99323 internal coolant cutter.

# 03

Feature

## Special insert geometry - exceptional swarfs control.

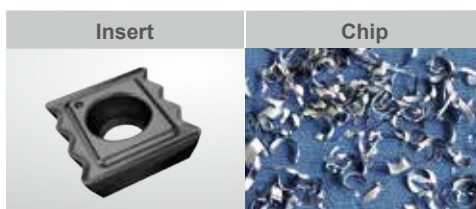

- Serrated cutting edge makes the chips short and small, and easier to evacuate.
- Eliminate swarf and vibration problems while drilling difficult material or deeper holes.
- Excellent swarfs control for providing safe and rational chip removal for modern automation.



3

NC Helix Drill

# “One tool” performs multiple applications

04  
Feature



- Not only a drill, but an end mill too.
- Small radius path to cut a hole or step hole, various curved cavity shapes on different materials, reduce tool number and cutting time.

## Functions in variable conditions It's so easy!

05  
Feature

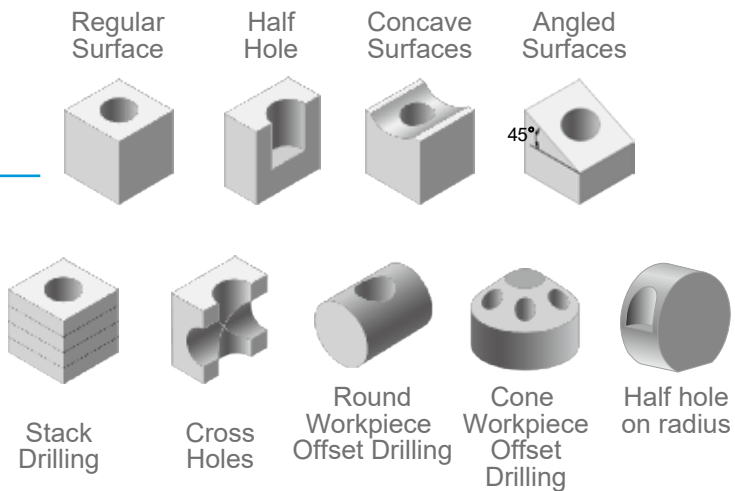

## Roughness Measuring Feature 06

- Making a flatness at bottom just by NC program, easy and smart!

**Workpiece**



Make “One more turn” after reached the depth.  
Ex :  
...  
G03 I-1.5 Z-30 P5  
G03 I-1.5 <make one more turn >  
G01 X0 Y0 < afterward, let tool back to center of hole >

Flatness

```

Partnumber: 01
Object
Name
#
Lt 0.520 mm
La Standard 0.200 mm
Lc 0.300 mm
Rc 1.270 mm
Rz 6.61 µm
Rmax 7.71 µm
RPa(0.5, -0.2) 4.0 µm
R Profile
Lc 0.480 mm
Vc 0.300 mm
    
```

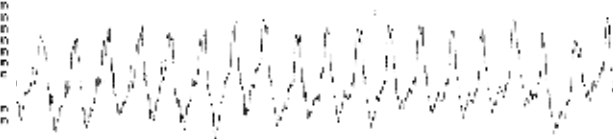

Strength

Opportunities

Extraordinary

ures

3  
NC Helix Drill

# Insert

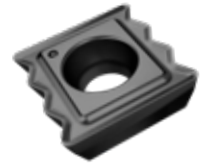

**NC5072** : P40, TiAlN coating.

General purpose, suitable for almost all kind of steel, stainless steel and Titanium. Recommended while clamping devices is unstable or deep hole drilling or apply on low power machines .

**NC2032** : K20F, TiAlN coating.

Design for high performance cutting, special good for cast iron and hardened material <HRC50°.

● Best ◎Suit ○Possible

		P Steel	M SS	K Cast Iron	N Aluminum	S Titanium	H Hardened
<b>NC5072</b>		●	●	◎	◎	◎	○
<b>NC2032</b>		◎	○	●	◎	○	◎

Code	Parts No.	Grade	Coating		Dimensions			Screw	Key
					L	S	Re		
041021	01-N9MX04T002	NC5072	P40	TiAlN	4.75	1.8	0.2	*NS-18037 0.6Nm	NK-T6
041001		NC2032	K20F						
042021	01-N9MX05T103	NC5072	P40	TiAlN	5.75	2.0	0.3	*NS-20045 0.6Nm	NK-T6
042001		NC2032	K20F						
043021	01-N9MX070204	NC5072	P40	TiAlN	7.5	2.4	0.4	*NS-25045 0.9Nm	NK-T7
043001		NC2032	K20F						
044021	01-N9MX100306	NC5072	P40	TiAlN	10.0	3.18	0.6	NS-30072 2.0Nm	NK-T9
044001		NC2032	K20F						
045021	01-N9MX12T308	NC5072	P40	TiAlN	12.5	3.97	0.8	NS-35080 2.5Nm	NK-T15
045001		NC2032	K20F						

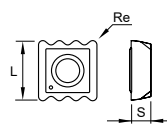

\*Torque screwdriver is recommended.

## 3

# Holder

NC Helix Drill

### ► Cylindrical Shank >>

- Made from hardened high alloy steel 48 HRC.
- Unique helical groove design generates chip-removing coolant stream.
- Designed for CNC machine with external coolant.

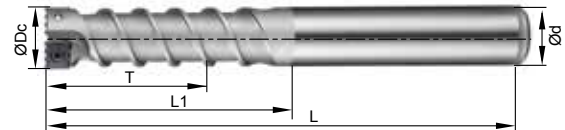

Code	Parts No.	Type	Capable of drill dia. mm		ØDc	T	L1	L	Ød	Insert type	Max. ramping angle
			Dmin.	Dmax.							
401001	00-99321-010-1320	BC10-HD11-1320	13	20	11	30	40	80	10	N9MX04T002	20°
402001	00-99321-012-1525	BC12-HD13-1525	15	25	13	36	50	100	12	N9MX05T103	20°
403001	00-99321-016-2030	BC16-HD17-2030	20	30	17	50	60	110	16	N9MX070204	20°
404001	00-99321-020-2540	BC20-HD22-2540	25	40	22	60	70	125	20	N9MX100306	20°
405001	00-99321-025-3050	BC25-HD27-3050	30	50	27	75	85	165	25	N9MX12T308	20°

### ► Side Lock Shank >>

- Made from hardened high alloy steel 48 HRC.
- With internal coolant
- Special size is available on request.

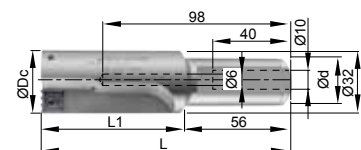

Code	Parts No.	Type	Capable of drill dia. mm		ØDc	L	L1	Ød	Max. Depth	Insert type	Max. ramping angle
			Dmin.	Dmax.							
405002	00-99321-025-4265	SL25-HD33-4265	42	65	33	130	74	25	50	N9MX12T308	9°

## ► Screw Fit Cutter >>

- Made from hardened high alloy steel 42 HRC.
- With internal coolant.
- Standard screw-fit body adapts to almost any kinds of the screw-fit tool holder or extension bar in the market.
- Possible to apply for enlarge hole.

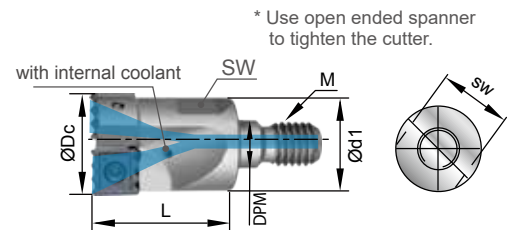

Code	Part No.	Type	Capable of drill dia. mm		ØDc	L	M	DPM	Ød1	SW	Insert type	Max. ramping angle
			Dmin.	Dmax.								
421001	00-99323-010-1320	M05-HD11-1320	13	20	11	20	M5	5.5	10	8	N9MX04T002	20°
422001	00-99323-012-1525	M06-HD13-1525	15	25	13	25	M6	6.5	12	10	N9MX05T103	20°
423001	00-99323-016-2030	M08-HD17-2030	20	30	17	25	M8	8.5	16	14	N9MX070204	20°
424001	00-99323-020-2540	M10-HD22-2540	25	40	22	30	M10	10.5	20	18	N9MX100306	20°
425001	00-99323-025-3050	M12-HD27-3050	30	50	27	35	M12	12.5	25	23	N9MX12T308	20°

\* Special size is available by request.

## Extension Bar

### ► Steel Type >>

- T is the maximum overhang length.
- With internal coolant hole.

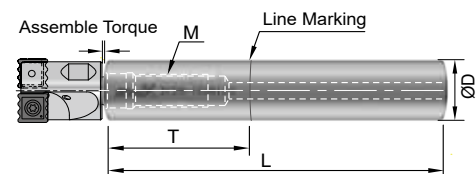

Code	Parts No.	Type	ØD	T	L	M	Assembled Torque
970100	00-99801-10S	BC10-075M05S	10	25	75	M5xP0.8	6.5 Nm
970122	00-99801-12S	BC12-075M06S	12	25	75	M6xP1.0	11.0 Nm
970161	00-99801-16S	BC16-090M08S	16	35	90	M8xP1.25	25.0 Nm
970202	00-99801-20S	BC20-100M10S	20	40	100	M10xP1.5	50.0 Nm
970253	00-99801-25S	BC25-120M12S	25	50	120	M12xP1.75	60.0 Nm

### ► Solid Carbide Type (REVA) >>

- T is the maximum overhang length.
- With internal coolant hole.
- Carbide extension bar with longer tool length is available on request.

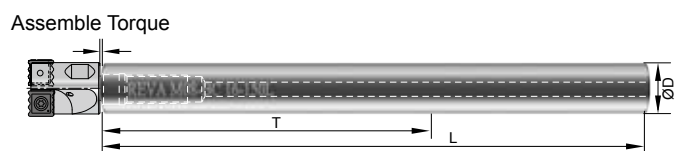





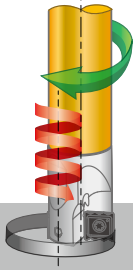
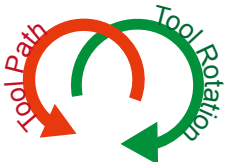

Parts No.	Type	ØD	T	L	M	Assembled Torque
0-398010-100M05	M05-BC10-100L	10	60	100	M5xP0.8	6.5 Nm
0-398012-100M06	M06-BC12-100L	12	60	100	M6xP1.0	11.0 Nm
0-398016-150M08	M08-BC16-150L	16	80	150	M8xP1.25	25.0 Nm
0-398020-200M10	M10-BC20-200L	20	100	200	M10xP1.5	50.0 Nm
0-398025-200M12	M12-BC25-200L	25	125	200	M12xP1.75	60.0 Nm

\*\* Nine9 TiN coated extension bar is also available please refer to page 7-159.

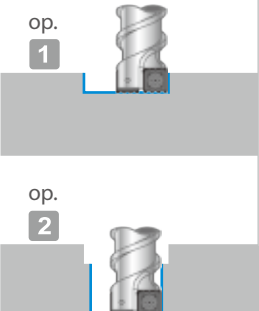
# Technical Guide

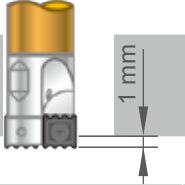
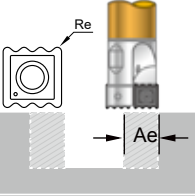
※ Before you start, please pay attention the following conditions >>

<b>1</b>	<b>2</b>	<b>3</b>	<b>4</b>	<b>5</b>														
<b>Programming</b> All NC Helix Drills must be programmed using helical interpolation 	<b>Recommend of Direction</b> Tool path of moving downward by CCW (G03), Tool Rotation by CW direction is recommended. 	<b>Flatness on blind hole bottom</b> Make <u>one more turn</u> after reaching depth. Ex.: G03 I-1.5 Z-30 P5 G03 I-1.5 <make one more turn > G01 X0 Y0 < afterward return tool back to center of hole > 	<b>Step Hole</b> From solid is more safe and reduce the cutting time. 	<b>External coolant</b> Lower pressure higher volume is recommended. Minimum 5 bar. Aim nozzle toward the tool body, let the coolant effectively enter the hole. 														
<b>6</b>	<b>7</b>	<b>8</b>	<b>9</b>	<b>10</b>														
<b>For Start</b> <table border="1"> <tr> <td>Vc</td> <td>fz</td> <td>Pitch</td> </tr> <tr> <td></td> <td></td> <td>By Spindle Power</td> </tr> </table> <p>Result adjusting</p> <table border="1"> <tr> <td>Upgrade</td> <td>Improve</td> </tr> <tr> <td>P ↑ adj. 1</td> <td>fz ↓ adj. 1</td> </tr> <tr> <td>Vc ↑ adj. 2</td> <td>P ↓ adj. 2</td> </tr> <tr> <td>fz ↓ adj. 3</td> <td></td> </tr> </table>	Vc	fz	Pitch			By Spindle Power	Upgrade	Improve	P ↑ adj. 1	fz ↓ adj. 1	Vc ↑ adj. 2	P ↓ adj. 2	fz ↓ adj. 3		<b>Through hole</b> To avoid insert breakage due to the force from circular interpolation, <b>reduce Vc 50% at last cycle.</b> 	<b>Through hole Add 1mm to the required depth (Z)</b> To make sure there is no material left in the hole. 	<b>Enlarge Hole</b> Choosing a 99323 drill body with internal coolant. Max. Ae=Dc- (Rex2) for enlarging hole. 	<b>Internal coolant</b> High pressure is recommended. Minimum 10 bar. Recommended for 3xDc ~8xDc Use. 
Vc	fz	Pitch																
		By Spindle Power																
Upgrade	Improve																	
P ↑ adj. 1	fz ↓ adj. 1																	
Vc ↑ adj. 2	P ↓ adj. 2																	
fz ↓ adj. 3																		

3

NC Helix Drill

## ※ Choosing a suitable drill body.

- Required hole diameter is within the recommended range (blue numbers).
- Required hole diameters ( more than one size), choose the drill can cover more different hole diameters.
- For 3xDc~8xDc drilling, 99323 series is recommended.

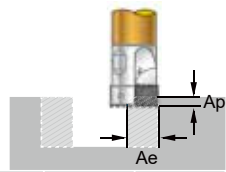

Drilling diameter	Coolant type	Max. drilling depth	Tool type	Dc	Insert type	Re	Min. Ae	Max. Ae	Max. Ap
13-15-20	Internal	80 mm	00-99323-010-1320	11	N9MX04T002	0.2	1.58	10.6	3.5
	External	30 mm	00-99321-010-1320	11					
15-20-25	Internal	85 mm	00-99323-012-1525	13	N9MX05T103	0.3	1.92	12.4	4.3
	External	36 mm	00-99321-012-1525	13					
20-25-30	Internal	105 mm	00-99323-016-2030	17	N9MX070204	0.4	2.5	16.2	5.6
	External	50 mm	00-99321-016-2030	17					
25-30-40	Internal	130 mm	00-99323-020-2540	22	N9MX100306	0.6	3.3	20.8	7.5
	External	60 mm	00-99321-020-2540	22					
30-40-50	Internal	160 mm	00-99323-025-3050	27	N9MX12T308	0.8	4.17	25.4	9
	External	75 mm	00-99321-025-3050	27					
42-50-65	Internal	50 mm	00-99321-025-4265	33	N9MX12T308	0.8	4.17	31.4	9

Min. Ae = 1/3 insert length (L). Max. Ae = Dc- (Rex2)  
Max. Ap < 3/4 of insert length

※ The NC Helix Drill is programmed using "Helical interpolation" on CNC machine, CNC controller must have 3-axis simultaneously motion function.

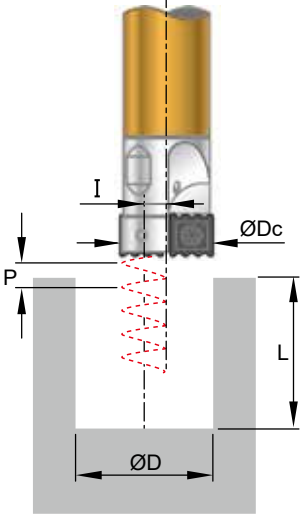
NC Helix Drill	Cutting Parameters (S & F)	Formula
	$S = \frac{Vc \times 1000}{Dc \times \pi} \text{ r.p.m.}$	Dc = Dia. of drill mm
	$F = S \times fz \times Z \text{ mm/min.}$	D = Dia. of hole mm
	$d = D - Dc \text{ mm}$	L = Depth of drilling mm
	$I = \frac{(D-Dc)}{2} \text{ mm}$	Vc = Cutting speed m/min.
	<b>Cutting time (T)</b>	S = Spindle speed r.p.m.
	$T = \frac{\pi \times d \times L \times 60}{F \times P} \text{ sec.}$	I = Circular radius mm
	<b>Chip removal Volume rate (Q)</b>	fz = Feed rate mm/tooth
	$Q = \frac{\pi \times D^2 \times L \times 60}{4 \times 1000 \times T} \text{ cm}^3 / \text{min.}$	F = Table feed rate mm/min.
		d = Circular diameter (D-Dc) mm
		P = Pitch of helical interpolation mm
	T = Cutting time sec.	
	Q = Chip removal volume rate cm <sup>3</sup> / min.	
	Z = Insert tooth	

### Actual Feed Rate (f<sub>cut</sub>)

As different spindle power, you can reference this table, f<sub>cut</sub>= fz x (PF), then you can get the actual feed rate.

Spindle Type	BT-30 Small power			BT-40 Medium power			BT-50 Big power		
Spindle Power (KW)	< 5	7	10	12	16	20	22	25	> 30
Power Factor (PF)	0.8	0.85	0.9	0.95	1	1.05	1.1	1.15	1.2

### Ramping Angle

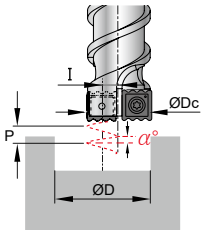
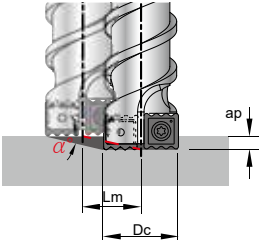
Circular ramping (α)	Linear ramping (α)
 $\alpha = \tan^{-1} \frac{P}{(D-Dc) \times \pi} \text{ degree}$ <p>P &lt; 2.2 x Circular radius (I) α &lt; 20°</p>	 $\alpha = \tan^{-1} \frac{ap}{Lm} \text{ degree}$ <p>Max. ap &lt; 3/4 of insert length</p>

※ Length of tool path for linear ramping.

Length of tool path for Circular ramping= (D-Dc) x 3.14

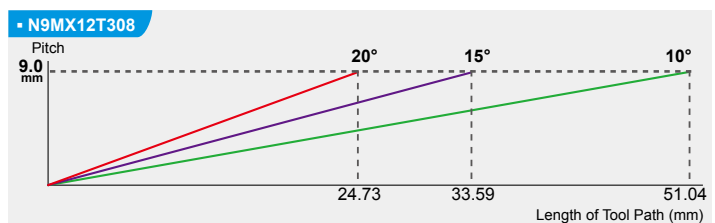
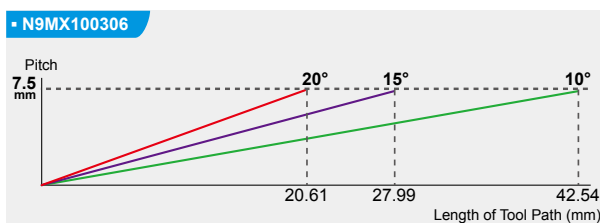
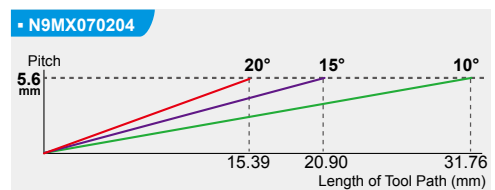
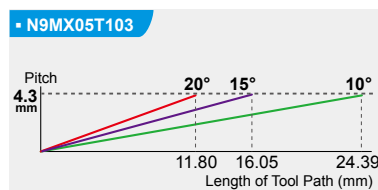
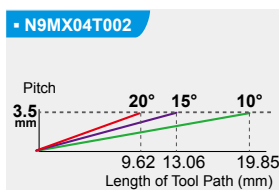



# Cutting Data

Suggestion Table			
Spindle Power	< 12 KW	12-20 KW	> 20 KW
Pitch	Lower Pitch	Medium Pitch	Higher Pitch

▶ 00-99321-010-1320 / 00-99323-010-1320 >>

Workpiece material	Vc m/min.		Ø13			Ø16			Ø20					
	99321	99323	fz mm/tooth	Pitch mm		fz mm/tooth	Pitch mm		fz mm/tooth	Pitch mm				
<b>P</b> Carbon steel 0.25%C	120	200	0.025	0.60	0.80	1.00	0.055	0.90	1.20	1.50	0.08	1.20	1.60	2.00
	120	200	0.025	0.60	0.80	1.00	0.055	0.90	1.20	1.50	0.08	1.20	1.60	2.00
	100	150	0.025	0.60	0.75	0.90	0.05	0.80	1.10	1.35	0.07	1.00	1.40	1.80
	70	120	0.02	0.50	0.65	0.80	0.05	0.70	0.95	1.20	0.06	1.00	1.30	1.60
	60	90	0.02	0.50	0.65	0.80	0.05	0.70	0.95	1.20	0.06	1.00	1.30	1.60
<b>M</b> Stainless steel	60	90	0.02	0.50	0.65	0.80	0.05	0.70	0.95	1.20	0.06	1.00	1.30	1.60
<b>K</b> Cast iron	70	120	0.025	0.60	0.80	1.00	0.055	0.90	1.20	1.50	0.08	1.20	1.60	2.00
<b>N</b> Al	345	500	0.025	0.90	1.20	1.50	0.055	1.30	1.80	2.25	0.08	1.80	2.40	3.00
	200	400	0.025	0.70	0.95	1.20	0.055	1.00	1.40	1.80	0.08	1.40	1.90	2.40
<b>S</b> Ni-alloy	20	28	0.01	0.50	0.65	0.80	0.015	0.70	0.95	1.20	0.03	0.90	1.30	1.60
	40	60	0.01	0.50	0.65	0.80	0.015	0.70	0.95	1.20	0.03	0.90	1.30	1.60
<b>H</b> Hardened	60	90	0.02	0.50	0.65	0.80	0.05	0.70	0.95	1.20	0.06	1.00	1.30	1.60

▶ 00-99321-012-1525 / 00-99323-012-1525 >>

Workpiece material	Vc m/min.		Ø15			Ø20			Ø25					
	99321	99323	fz mm/tooth	Pitch mm		fz mm/tooth	Pitch mm		fz mm/tooth	Pitch mm				
<b>P</b> Carbon steel 0.25%C	120	200	0.035	1.20	1.60	2.00	0.065	1.50	2.00	2.50	0.09	1.80	2.40	3.00
	120	200	0.035	1.20	1.60	2.00	0.065	1.50	2.00	2.50	0.09	1.80	2.40	3.00
	100	150	0.03	1.10	1.50	1.80	0.06	1.30	1.78	2.25	0.08	1.60	2.15	2.70
	70	120	0.025	1.00	1.30	1.60	0.05	1.20	1.60	2.00	0.07	1.40	1.90	2.40
	60	90	0.025	1.00	1.30	1.60	0.05	1.20	1.60	2.00	0.07	1.40	1.90	2.40
<b>M</b> Stainless steel	60	90	0.025	1.00	1.30	1.60	0.05	1.20	1.60	2.00	0.07	1.40	1.90	2.40
<b>K</b> Cast iron	70	120	0.035	1.20	1.60	2.00	0.065	1.30	1.90	2.50	0.09	1.80	2.40	3.00
<b>N</b> Al	345	500	0.035	1.80	2.00	2.20	0.065	2.20	2.98	3.75	0.09	2.70	3.60	4.30
	200	400	0.035	1.40	1.90	2.20	0.065	1.80	2.40	3.00	0.09	2.10	2.85	3.60
<b>S</b> Ni-alloy	20	28	0.0125	1.00	1.30	1.60	0.0225	1.20	1.60	2.00	0.03	1.40	1.90	2.40
	40	60	0.0125	1.00	1.30	1.60	0.0225	1.20	1.60	2.00	0.03	1.40	1.90	2.40
<b>H</b> Hardened	60	90	0.025	1.00	1.30	1.60	0.05	1.20	1.60	2.00	0.07	1.40	1.90	2.40



3

NC Helix Drill



# Cutting Data

Suggestion Table			
Spindle Power	< 12 KW	12-20 KW	> 20 KW
Pitch	Lower Pitch	Medium Pitch	Higher Pitch

## ► 00-99321-016-2030 / 00-99323-016-2030 >>

Workpiece material	Vc m/min.		Ø20			Ø25				Ø30				
			fz mm/tooth	Pitch mm			fz mm/tooth	Pitch mm			fz mm/tooth	Pitch mm		
<b>P</b> Carbon steel 0.25%C	120	200	0.04	1.80	2.40	3.00	0.08	2.10	2.80	3.50	0.105	2.40	3.20	4.00
	120	200	0.04	1.80	2.40	3.00	0.08	2.10	2.80	3.50	0.105	2.40	3.20	4.00
	100	150	0.035	1.60	2.15	2.70	0.07	1.90	2.55	3.20	0.09	2.10	2.85	3.60
	70	120	0.03	1.40	1.90	2.40	0.065	1.60	2.20	2.80	0.08	1.90	2.55	3.20
	60	90	0.03	1.40	1.90	2.40	0.065	1.60	2.20	2.80	0.08	1.90	2.55	3.20
<b>M</b> Stainless steel	60	90	0.03	1.40	1.90	2.40	0.065	1.60	2.20	2.80	0.08	1.90	2.55	3.20
<b>K</b> Cast iron	70	120	0.04	1.80	2.40	3.00	0.08	2.10	2.80	3.50	0.105	2.40	3.20	4.00
<b>N</b> Al	345	500	0.04	2.70	3.00	3.40	0.08	3.10	4.05	5.00	0.105	3.60	4.80	5.60
	200	400	0.04	2.10	2.85	3.40	0.08	2.50	3.35	4.20	0.105	2.80	3.80	4.80
<b>S</b> Ni- alloy	20	28	0.015	1.40	1.90	2.40	0.03	1.60	2.20	2.80	0.04	1.90	2.55	3.20
	40	60	0.015	1.40	1.90	2.40	0.03	1.60	2.20	2.80	0.04	1.90	2.55	3.20
<b>H</b> Hardened	60	90	0.03	1.40	1.90	2.40	0.065	1.60	2.20	2.80	0.08	1.90	2.55	3.20

## ► 00-99321-020-2540 / 00-99323-020-2540 >>

Workpiece material	Vc m/min.		Ø25			Ø32				Ø40				
			fz mm/tooth	Pitch mm			fz mm/tooth	Pitch mm			fz mm/tooth	Pitch mm		
<b>P</b> Carbon steel 0.25%C	120	200	0.05	1.80	2.40	3.00	0.095	2.40	3.20	4.00	0.12	3.00	4.00	5.00
	120	200	0.05	1.80	2.40	3.00	0.095	2.40	3.20	4.00	0.12	3.00	4.00	5.00
	100	150	0.04	1.60	2.15	2.70	0.08	2.20	2.90	3.60	0.11	2.70	3.60	4.50
	70	120	0.035	1.40	1.90	2.40	0.07	1.90	2.55	3.20	0.095	2.40	3.20	4.00
	60	90	0.035	1.40	1.90	2.40	0.07	1.90	2.55	3.20	0.095	2.40	3.20	4.00
<b>M</b> Stainless steel	80	90	0.035	1.40	1.90	2.40	0.07	1.90	2.55	3.20	0.095	2.40	3.20	4.00
<b>K</b> Cast iron	70	120	0.05	1.80	2.40	3.00	0.095	2.40	3.20	4.00	0.12	3.00	4.00	5.00
<b>N</b> Al	345	500	0.05	2.70	3.00	3.40	0.095	3.60	4.80	6.00	0.12	4.50	6.00	7.50
	200	400	0.05	2.10	2.85	3.40	0.095	2.90	3.85	4.80	0.12	3.60	4.80	6.00
<b>S</b> Ni- alloy	40	50	0.02	1.40	1.90	2.40	0.035	1.90	2.55	3.20	0.045	2.40	3.20	4.00
	80	90	0.02	1.40	1.90	2.40	0.035	1.90	2.55	3.20	0.045	2.40	3.20	4.00
<b>H</b> Hardened	80	90	0.035	1.40	1.90	2.40	0.07	1.90	2.55	3.20	0.095	2.40	3.20	4.00

3

NC Helix Drill

# Cutting Data

Suggestion Table			
Spindle Power	< 12 KW	12-20 KW	> 20 KW
Pitch	Lower Pitch	Medium Pitch	Higher Pitch

▶ 00-99321-025-3050 / 00-99323-025-3050 >>

Workpiece material	Vc m/min.		Ø30			Ø40				Ø50				
	99321	99323	fz mm/tooth	Pitch mm			fz mm/tooth	Pitch mm			fz mm/tooth	Pitch mm		
P Carbon steel 0.25%C Carbon steel 0.45% C Carbon steel 0.60%C Low alloy steel High alloy steel	120	200	0.055	2.40	3.00	3.40	0.12	3.00	4.00	5.00	0.135	3.60	4.80	6.00
	120	200	0.055	2.40	3.00	3.40	0.12	3.00	4.00	5.00	0.135	3.60	4.80	6.00
	100	150	0.05	2.20	2.90	3.40	0.10	2.70	3.60	4.50	0.12	3.20	4.30	5.40
	70	120	0.04	1.90	2.55	3.20	0.09	2.40	3.20	4.00	0.11	2.90	3.85	4.80
	60	90	0.04	1.90	2.55	3.20	0.09	2.40	3.20	4.00	0.11	2.90	3.85	4.80
M Stainless steel	60	90	0.04	1.90	2.55	3.20	0.09	2.40	3.20	4.00	0.11	2.90	3.85	4.80
K Cast iron	70	120	0.055	2.40	3.00	3.40	0.115	3.00	4.00	5.00	0.135	3.60	4.80	6.00
N Al Cu	345	500	0.055	2.50	3.00	3.40	0.115	4.50	6.00	7.50	0.135	5.40	7.20	9.00
	200	400	0.055	2.50	3.00	3.40	0.115	3.60	4.80	6.00	0.135	4.30	5.75	7.20
S Ni-alloy Titanium	20	28	0.02	1.90	2.55	3.20	0.045	2.40	3.20	4.00	0.055	2.90	3.85	4.80
	40	60	0.02	1.90	2.55	3.20	0.045	2.40	3.20	4.00	0.055	2.90	3.85	4.80
H Hardened	60	90	0.04	1.90	2.55	3.20	0.09	2.40	3.20	4.00	0.11	2.90	3.85	4.80

▶ 00-99321-025-4265 >>

Workpiece material	Vc m/min.	Ø42			Ø55				Ø65				
	99321	fz mm/tooth	Pitch mm			fz mm/tooth	Pitch mm			fz mm/tooth	Pitch mm		
P Carbon steel 0.25%C Carbon steel 0.45% C Carbon steel 0.60%C Low alloy steel High alloy steel	200	0.08	3.00	3.60	4.40	0.12	3.30	4.40	5.50	0.135	3.60	4.80	6.00
	150	0.08	3.00	3.60	4.40	0.12	3.30	4.40	5.50	0.135	3.60	4.80	6.00
	130	0.075	2.70	3.60	4.40	0.11	3.00	4.00	5.00	0.12	3.20	4.30	5.40
	120	0.065	2.40	3.20	4.00	0.095	2.60	3.50	4.40	0.11	2.90	3.85	4.80
	90	0.065	2.40	3.20	4.00	0.095	2.60	3.50	4.40	0.11	2.90	3.85	4.80
M Stainless steel	90	0.065	2.40	3.20	4.00	0.095	2.60	3.50	4.40	0.11	2.90	3.85	4.80
K Cast iron	120	0.08	3.00	3.60	4.40	0.12	3.30	4.40	5.50	0.135	3.60	4.80	6.00
N Al Cu	500	0.08	4.00	4.20	4.40	0.12	4.90	6.55	8.20	0.135	5.40	7.20	9.00
	200	0.08	3.60	4.00	4.40	0.12	4.00	5.30	6.60	0.135	4.30	5.75	7.20
S Ni-alloy Titanium	28	0.03	2.40	3.20	4.00	0.045	2.60	3.50	4.40	0.055	2.90	3.85	4.80
	90	0.03	2.40	3.20	4.00	0.045	2.60	3.50	4.40	0.055	2.90	3.85	4.80
H Hardened	90	0.065	2.40	3.20	4.00	0.095	2.60	3.50	4.40	0.11	2.90	3.85	4.80

3

NC Helix Drill

# Application Example

## ► Special insert geometry is able to cut different materials >>

- Serrated cutting edge makes the chips short and small, and easier to evacuate.
- Recommended for almost all material types, good for drilling material that generates long, soft chips.

### Example 1



SAE8620

SUS304

C1100

AL6061T6

TiAl6V4

Inconel 718

BT40, 22.5KW | Hole size: Ø25 x 50L mm | Tool: 00-99321-016-2030

#### Material: SAE8620

Load 25% **P**

Vc	=	120	m/min.
S	=	2250	r.p.m.
fz	=	0.08	mm/tooth
F	=	360	mm/min
P	=	5.6	mm
T	=	40	sec.



#### Material: SUS304 (Stainless steel 304)

Load 25% **M**

Vc	=	80	m/min.
S	=	1500	r.p.m.
fz	=	0.04	mm/tooth
F	=	120	mm/min
P	=	5.6	mm
T	=	118	sec.

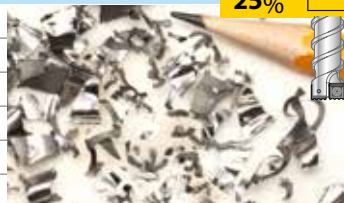

#### Material: C1100

Load 25% **N**

Vc	=	200	m/min.
S	=	3750	r.p.m.
fz	=	0.08	mm/tooth
F	=	600	mm/min
P	=	5.6	mm
T	=	23	sec.



#### Material: AL6061T6

Load 20% **N**

Vc	=	345	m/min.
S	=	6500	r.p.m.
fz	=	0.10	mm/tooth
F	=	1300	mm/min
P	=	5.6	mm
T	=	11	sec.

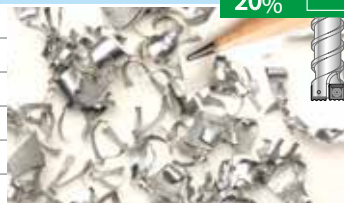

#### Material: TiAl6V4

Load 24% **S**

Vc	=	80	m/min.
S	=	1500	r.p.m.
fz	=	0.04	mm/tooth
F	=	120	mm/min
P	=	5.6	mm
T	=	118	sec.



#### Material: Inconel 718 (Drill with internal coolant)

Load 24% **S**

Vc	=	40	m/min.
S	=	750	r.p.m.
fz	=	0.15	mm/tooth
F	=	225	mm/min
P	=	2.0	mm
T	=	177	sec.



## ► Suggested insert grades for best result >>

Example 2	Diameter (mm)	25			
	Depth (mm)	50			
	Tool (Dc=17mm)	00-99321-016-2030 (external coolant)			
	Material		<b>P</b> Carbon Steel	<b>M</b> Stainless Steel	<b>H</b> Tool Steel
		DIN	C45E	X5CrNi18-10	X40CrMoV5 1
		SAE	1045	304	H13
	JIS	S45C	SUS304	SKD61 (HRC50°)	
	Insert Grade	<b>NC5072</b> (P40, TiAlN)	<b>NC5072</b> (P40, TiAlN)	<b>NC2032</b> (K20F, TiAlN)	
	No. of Edges	2	2	2	
	Vc = (m/min.)	120	60	80	
	S = r.p.m.	2250	1120	1500	
	fz = (mm/tooth)	0.1	0.065	0.05	
	F = (mm/min.)	450	146	150	
	Pitch = (mm)	5.6	3	3	
Machine Load = % (BT40, 22.5KW)	35%	20%	20%		
Tool Life (hole)	150	108	18		
Chip Removal Volume (cm³/min.)	52.66	8.55	8.77		

► To produce step hole Ø53.5 & Ø45 by one tool >>



Example 3

Application

- Hydraulic port for plug-in valve cylinders, counterbore for bolt, and more!



<b>Material</b>	S50C (JIS). High carbon steel									
<b>Tool</b>	99323-LS32-HD40 (Non-standard size)									
<b>Insert</b>	N9MX12T308-NC2032									
<b>Machine</b>	BT40, 22.5 KW									
<b>Coolant</b>	Internal									
Hole	Dc mm	D mm	L mm	Vc m/min.	S r.p.m.	fz mm/tooth	F mm/min.	I mm	P mm	T sec.
A	Ø40	Ø53.5	10	300	2400	0.08	380	6.75	5.0	13.3
B		Ø45.0	32	300	2400	0.08	380	2.5	2.0	39.48

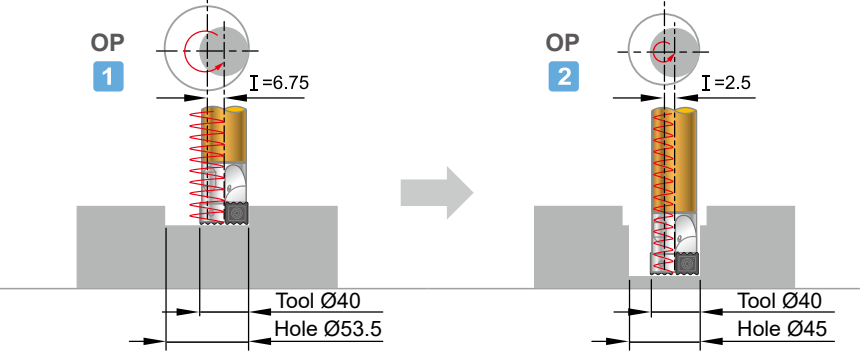

► Just one “NC Helix Drill” can machine different diameters and hole depths.

► Just one tool to drill different diameters and hole depth, possible up to 6xDc >>

3

NC Helix Drill

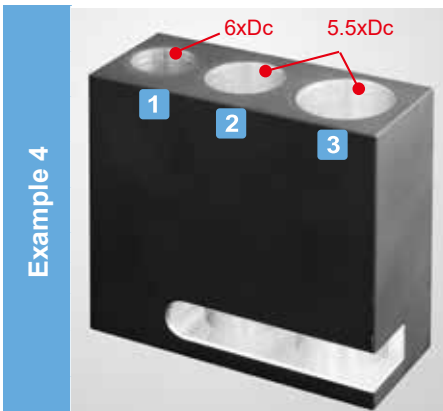

Example 4

<b>Material</b>	AL6061T6										
<b>Tool</b>	00-99323-016-2030										
<b>Insert</b>	N9MX070204-NC5072										
<b>Machine</b>	HAAS VM-3, BT40, 22.5KW										
<b>Coolant</b>	Internal coolant										
Fig.	Dc mm	D mm	I mm	L mm	Vc m/min.	S r.p.m.	fz mm/tooth	fcut mm/tooth	F mm/min.	P mm	α deg
1		20	1.5	100	500	9360	0.04	0.058	1090	3	17.67
2	Ø17	25	4	95	500	9360	0.08	0.103	1930	4.5	10.16
3		30	6.5	95	500	9360	0.105	0.131	2450	5.6	7.81

► Low spindle power is not a problem!  
BT30 machine, Ø30 hole diameter, 3.3xDc drill depth >>

The main purpose of this example is to improve machining efficiency.

Maximum drilling capacity of the 5.5 kw spindle is Ø16 mm

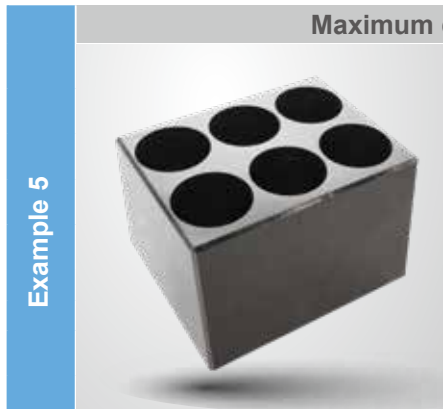

Example 5

<b>Material</b>	S50C (JIS), High carbon steel									
<b>Tool</b>	00-99321-020-2540 / BC20-HD22-2540									
<b>Insert</b>	N9MX100306-NC2032									
<b>Machine</b>	BT30, 5.5 KW									
<b>Coolant</b>	External coolant									
Dc mm	D mm	L mm	Vc m/min.	S r.p.m.	fz mm/tooth	fcut mm/tooth	F mm/min.	I mm	P mm	T sec.
Ø22	Ø30	60	200	* 2893	0.12	0.1	600	4	2.8	62

\* 3000 r.p.m. is used.

▶ One tool performs multiple patterns >> (this is only programming example, no refer to cutting parameters)

Example 6										
		<b>Material</b>	AL6061T6							
		<b>Tool</b>	00-99323-016-2030 M08-HD17-2030							
		<b>Insert</b>	N9MX070204-NC5072							
		<b>Machine</b>	HAAS VM-3, BT40, 22.5KW							
		<b>Coolant</b>	Internal							
<b>Fig.</b>	<b>Dc mm</b>	<b>Vc m/min.</b>	<b>S r.p.m.</b>	<b>fz mm/tooth</b>	<b>F mm/min.</b>	<b>P mm</b>	<b>T sec.</b>			
1		200	3800	0.075	570	4	67			
2	Ø17	200	3800	0.075	570	4	95			
3		200	3800	0.075	570	4	80			
<b>Tool Path</b> 										
<pre> % G40 G80 G69 G28 G91 Z0 G28 G91 X0 Y0 G00 G90 G126 G00 G90 X0. Y0. G52 X18. Y-20. G00 G90 X0. Y0. T5 M06 #1= 6.5 (X1) #11= -6.5 (X1=-I) #6= 1.5 (X2) #7= -1.5 (X2=-I) #2= 0. (Y) #3= 2.0 (Z1-1) #13= -2.0 (Z1-2) #16= -10.0 (Z1-1) #17= -12.0 (Z1-2) #4= 190.0 (F1-1) #5= 570.0 (F1-2) #14= 190.0 (F1-1) #15= 380.0 (F1-2) #8= 3 (L1=Depth/P#9) #9= 4.0 (P1=Z#3-DOWN Pitch) #18= 7 (L2=Depth/P#9) #19= 2.0 (P2=Z#16-DOWN Pitch) M88 G00 G90 X#1 Y#2 S3800 M03 G43 H05 Z30. (M08) Z10. Z5. G01 Z#3 F#4 M97 P1000 L#8 G03 I#11 F#4 G01 X#6 Y#2 (Holes 2) M97 P2000 L#18 G03 I#7 F#14 G01 X0. Y0. G00 G90 Z10. M05 G00 G90 Z20. M89 G00 G90 Z30. M09 G28 G91 Z0. M05 M00 G28 G91 Y0. M30 N1000 G03 I#11 Z#13 F#5 #13= #13 - #9 M99 N2000 G03 I#7 Z#17 F#15 #17= #17 - #19 M99 % </pre>		<pre> % G40 G80 G69 G28 G91 Z0 G28 G91 X0 Y0 G00 G90 G126 G00 G90 X0. Y0. G52 X0. Y0. G00 G90 X0. Y0. T5 M06 #12= 1.0 (Z-UP) #13= 0.0 (Z1) #14= -1.512 (Z2) #15= -2.608 (Z3) #16= -2.904 (Z4) #17= -4.0 (Z5-1) (Z2-1) #4= 190.0 (F1) #5= 570.0 (F2) #7= -6.5 (X2=-I) #18= -12.0 (Z2-2) #19= 4.0 (P2=Z#17-DOWN PITCH) G00 G90 X25. Y-51. M88 S3800 M03 G43 H05 Z30. (M08) Z10. G01 Z#12 F#4 M97 P1000 L2 G01 X35.757 Y-55.924 F#4 G03 X35.757 Y-46.076 R-6.5 G02 X15.537 Y-49.599 R20. G03 X15.537 Y-52.401 R-1.5 G02 X35.757 Y-55.924 R20. G01 X46.5 Y-51. M97 P2000 L3 G03 I#7 F#4 G01 X40. Y-51. G00 G90 Z10. M05 G00 G90 Z20. M89 G00 G90 Z30. M09 G28 G91 Z0. M05 M00 G28 G91 Y0. M30 N1000 G01 X35.757 Y-55.924 Z#13 F#4 G03 X35.757 Y-46.076 R-6.5 Z#14 F#5 % </pre>			<pre> G02 X15.537 Y-49.599 R20. Z#15 G03 X15.537 Y-52.401 R-1.5 Z#16 G02 X35.757 Y-55.924 R20. Z#17  #13= #13 - 4.0 #14= #14 - 4.0 #15= #15 - 4.0 #16= #16 - 4.0 #17= #17 - 4.0 M99  N2000 G03 I#7 Z#18 F#5 #18= #18 - #19 M99  % </pre>				<pre> % G40 G80 G69 G28 G91 Z0 G28 G91 X0 Y0 G00 G90 G126 G00 G90 X0. Y0. G52 X0. Y0. G00 G90 X0. Y0. T5 M06 #1= 4.0 (Z up) #2= 0.0 (Z1) #3= -4.0 (Z2) #4= 210.0 (F1) #5= 420.0 (F2) #6= 4.0 (Z#13-Pitch) G00 G90 X92.56 Y-14.507 M88 S2800 M03 G43 H05 Z30. (M08) Z10. Z5. M97 P1000 L5 (Z-Pitch) G00 G90 Z30. M05 M09 M89 G28 G91 Z0. M05 M00 G28 G91 Y0. M30  N1000  G00 G90 X92.56 Y-14.507 G01 Z#1 F#4 G02 X108.5 Y-20.416 Z#2 R72. F#5 G03 X92.56 Y-14.507 Z#3 R72. F#5 G01 Z#2 G03 X75.679 Y-12.5 Z#3 R72. F#5 G01 Z#2 G03 X58.798 Y-14.507 Z#3 R72. F#5 G01 Z#2 G03 X42.858 Y-20.416 Z#3 R72. F#5 G01 Z#2 G00 G90 Z5. #1= #1 - #6 (Z up) #2= #2 - #6 (Z1.) #3= #3 - #6 (Z2.) M99 % </pre>	